

2024

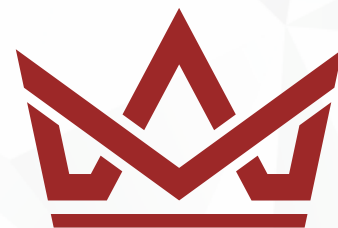

VIK KING

COMPOSITE DOORS & REAL WOOD WINDOWS

COMPOSITE ENTRY DOORS

edition: 1



We present to you a catalog of composite doors

// I am pleased to invite you to discover the fascinating world of energy-efficient composite doors in our latest catalogue. The **VIKING** team is not only breaking new ground, but also creating a future where the design meets innovation. I encourage you to explore our offer, where quality goes hand in hand with beauty. Discover with us how **VIKING** redefines the standards of comfort and style in the homes of customers around the world!

Tadeusz Konaszuk
Founder and CEO of VIKING

DOORS CONFIGURATOR



zobacz więcej

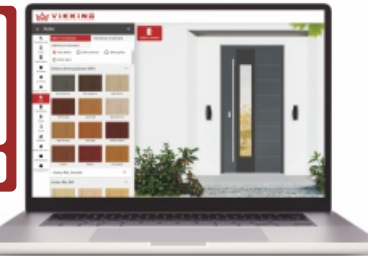

NEW 2024

FAMILY-OWNED COMPANY

Viking is a family company with **45 years of tradition**. We always adhere to the principle of business reliability. Credibility and honesty as well as a dedication to manufacturing products of the highest standard have been our vectors during our history. **This is confirmed by numerous certificates, awards and a constantly growing group of satisfied customers in over a dozen countries around the world.**

We have created a proprietary technology of energy-saving composite doors with superior technical parameters and aesthetic values in comparison to traditional products.

INNOVATIONS AND INTERNATIONAL PATENTS

LED lighting in the door leaf, an innovative composite door frame with a patented system of structural bonding of glazing with countless design and decoration options, and a unique combination in the on non-rebated on both sides version doors from the Ultimate line - this is just one example of the extensive range created by our R&D department. Satisfaction from a well-performed mission and continuous participation in the process of setting new trends is a priceless value for us.



Open up to new possibilities

We have combined advanced technology and innovative solutions with attention to every detail, so that each window and door stands out with precision, quality and optimal functionality, without any compromises in terms of durability and comfort of use characteristic of exclusive products.



CUSTOMIZED DOORS

The VIKKING brand is synonymous with customized joinery. Despite the global trend of product standardization, we are proud to be one of the few brands which offer tailor-made products. We design every composite door taking into account the most sophisticated expectations so that you can enjoy a reliable product for decades.

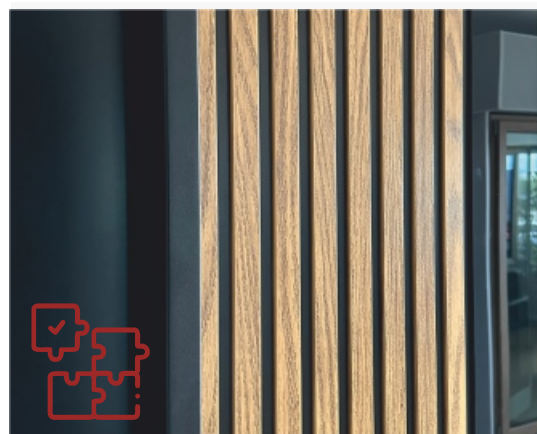

INNOVATION AND DESIGN

The ULTIMATE door line – the leaf and frame connection is flush on both sides and the whole product is made of composite materials. The wide range of solutions, sizes and fittings as well as the attractive appearance of hidden hinges ensure unique aesthetic values without any compromises in terms of quality and long-term maintenance-free durability. ULTIMATE doors are valued for their modern and elegant minimalism.

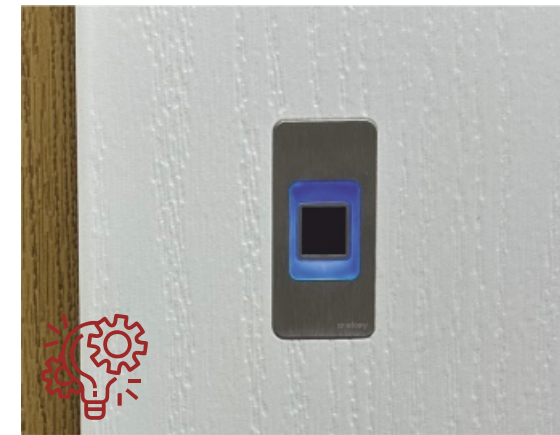

PERFECTLY MATCHED

Share your dreams with us, choose from our extensive range of the highest quality door handles and other accessories – we will compose them with the utmost care. Your safety and comfort of use will be increased thanks to our advanced remote-control systems and SMART HOME integration installations.



Brand - a guarantee of reliable products

Because we offer you composite doors of the highest quality and durability, regardless of the statutory requirements for the protection of consumer rights – we provide an extended warranty for trouble-free operation. This is an undeniable advantage of a composite door system that wood or metal cannot ensure.

CLEAR RULES:

- proper selection of doors and accessories adequate to the operating conditions,
- operation of the composite doors in accordance with their intended purpose,
- correct, warm fitting of doors by authorized fitters according to the manufacturer's instructions,
- performing periodic inspections, adjustments and maintenance according to the manufacturer's guidelines,
- immediate reporting of defects to prevent further damage to the door,
- use of the doors in an individual housing segment, for other applications a standard 3-year warranty applies.

WE PROVIDE WARRANTY AND POST-WARRANTY SERVICE.

The full content of the warranty provisions and instructions regarding quality acceptance, correct assembly, operation and maintenance are attached to each product in the language of the country of destination.

up to **25** years*

Composite door leaf
and frame

up to **20** years*

PVC frames, hinges
and lock catches

up to **10** years*

Varnish coatings,
stained glazing and seals

up to **3** years*

Strip locks and technical
efficiency of other
door components



YOU DON'T HAVE TO ACCEPT COMPROMISES!

Not all door manufacturers provide both the highest aesthetic values and the best home protection parameters.

We have created innovative composite doors from scratch to do just that – to meet even the most demanding expectations.

Advanced technology and innovative solutions allow us to produce the doors of your dreams without the slightest compromise in quality and durability!

No other door has so many advantages, without the disadvantages and limitations of traditional technologies. Composite doors are resistant to adverse weather conditions, they do not absorb moisture, do not corrode and maintain the highest quality for decades.

VIKING SPECIALIZES IN THE FULFILMENT OF EVEN THE MOST CUSTOMIZED ORDERS.

Unleash your creativity – start by changing your doors. Choose your style, any combination of colours and door surface textures. Choose the most convenient door handles and the most beautiful stained glass, and we will handle the rest with the utmost care.

To make it easier for our customers to select products, we have divided our doors according to lines, collections, models and accessories.



Table of contents

Advantages of composite doors 06

Door lines

ULTIMATE line	11
VISION line	12
ARCTIC PLUS line	13
ARCTIC line	14
TOP line	15

Collections

ELITE collection	18
CRYSTAL collection	20
VINTAGE collection	22
INSPIRO collection	26
TREND collection	30
FUTURE collection	36
VARIANT collection	40
CLASSIC collection	46

Accessories

Colors	52
Smart Home	54
Glazing packages	56
Sidelights	58
Door dimensions	61
Handles	62
Cylinders	68
Technical informations	69
Professional installation	73



Make your home stand out with custom design

SIDE AND UPPER LIGHTING

Only in the composite door system

We offer the possibility of using sidelights and top lights in any configuration, size and shape.

Line: ULTIMATE Collection:TREND Model: 05 15GM1



ALL THE COLOURS OF THE WORLD

Composite doors are varnished in all colours from the RAL palette, and can include special effects and wood-like decors. You can choose any configuration of colours you desire.

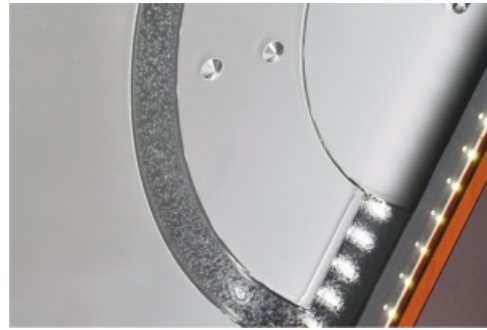

LED LIGHTING

LED lighting in glazing is an attractive and functional alternative to traditional lighting of the entrance. Vikking is one of the first brands to use integrated LED lighting in doors, including the threshold.



COLORS WITH SPECIAL EFFECT

Our proprietary varnishing technology allows to apply the PEARL, GALAXY or SAND effect on any color from the RAL palette.



HIDDEN HINGES

The ULTIMATE line sets new trends, and their functionality is increased by hidden hinges that allow the door leaf to open 180°.



ILLUMINATED DOOR LEAF

A gentle glow coming from under the composite wing provides soft illumination of the entrance area.



INDIVIDUAL DECORATIONS

Choose any design, content or decorations for your house number and we will make your ideas come to life.

63



Line: ULTIMATE Collection: CRYSTAL Model: 04 03 GC



PORTALS

A NEW LOOK FOR YOUR DOOR

A portal is a permanent door installation in a side layout, top layout, or any other configuration, and is an attractive architectural component. Portals, similarly to doors, are made of composite materials. That is why they are equally warm, durable and resistant to all weather conditions. A wide range of sizes and decorative solutions ensure freedom of choice in arranging the entrance to your home.

Available only in the ULTIMATE composite door line.





Comfort of use and functionality



SMART HOME – DOORS WITH SMART CONTROL

Is it possible to replace keys with a better solution? Of course, you can use a smartphone, keyboard, fingerprint reader, card or key ring.



FUNCTIONAL FITTINGS

A remote control, automatically locking multi-point lock, invisible closing device, electronic peephole, closing sensor – these are just a few of many innovative solutions for your comfort and security.



REINFORCED WITH FIBERGLASS

Thanks to the use of fiberglass technology, composite doors are impenetrable for intruders, they do not require tedious and frequent maintenance, and their unsurpassed durability ensures security for many years.

DURABLE AND RESISTANT TO DAMAGE

Composite doors are resistant to moisture and extreme weather conditions. The door leafs do not deform and are resistant to mechanical damage to a much greater extent than doors made of traditional materials. We guarantee their technical durability for decades.

UP TO
25 YEARS*
OF WARRANTY

*Ask your dealer for details.

U_d from
0,49*
W/m²K

THE WARMEST DOORS ON THE MARKET

Composite doors, unlike traditional metal or aluminum doors are made only of materials which protect against the loss of valuable energy. And this means measurable savings on heating the house in winter. All our composite door lines exceed the requirements of passive housing.



OUR DOORS DO NOT REQUIRE OVERHANGS

Composite doors, unlike metal and wooden doors, do not corrode, and are resistant to moisture and harmful UV radiation. As the only ones in their class, they do not require full overhang or maintaining minimum distances from heating devices inside the house.



WARM INTERCASE FRAMES IN GLAZING

All glazing in our composite doors have super warm frames between panes. The warm frame technology significantly improves the energy efficiency, soundproofing and lifetime of glass units.

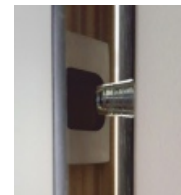

SECURE

The RC2 and RC3 anti-burglary class guarantees a sense of security. Composite doors are equipped with a system of multi-point locks and anti-theft bolts, which increases the level of security and protects against burglary.

Excellent parameters



ULTIMATE LINE

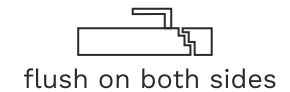
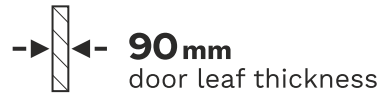

STANDARD ACCESSORIES

Standard fittings for complete external doors from the ULTIMATE line:

- 90 mm thick composite flush door leaf with a dedicated Real Wood composite door frame, optionally with a SMOOTH surface, at extra charge; optionally at extra charge: in any combination of both surfaces;
- 90x77 mm composite door frame with the same surface for the door leaf;
- combination: both sides flush with the frame;
- complete doors finished with the highest quality varnish in the RAL palette or in one of several wood-like decors, optionally without extra charge with the PEARL, GALAXY or SAND effect, optional at extra charge: finished in several pre-configured colors
- low aluminum threshold with a thermal insulation profile under the threshold; optional with extra charge with a system of warm sub-threshold profiles;
- three hidden hinges, 3D adjustable;
- anti-burglary bolt system;
- three-point anti-theft FUHR strip lock bolted with a handle, cylinder lock, or automatically;
- frame strip, adjustable;
- double, perimeter sealing system;
- wind-stop seal – an additional seal in the door sill;
- version with glazing: four-pane glazing with a warm frame system
- The price of the door includes one of many patterns of decorations from groups: 1, 2 or 3, optionally at extra charge: decorated stained glazing from group 4.
- Anti-burglary class RC2 or RC3 according to the European standard PN-EN 1627 - optional, at extra charge
- The price of the door includes a set of dedicated installation consoles.

anti-burglary class

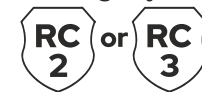

optional

do not require an overhang

hidden hinges

composite door frame



*Ask your dealer for details.

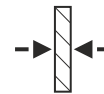

VISION LINE

 **75 mm**
door leaf thickness

 Ud from
0,53 W/m²K*
thermal insulation

rebated system

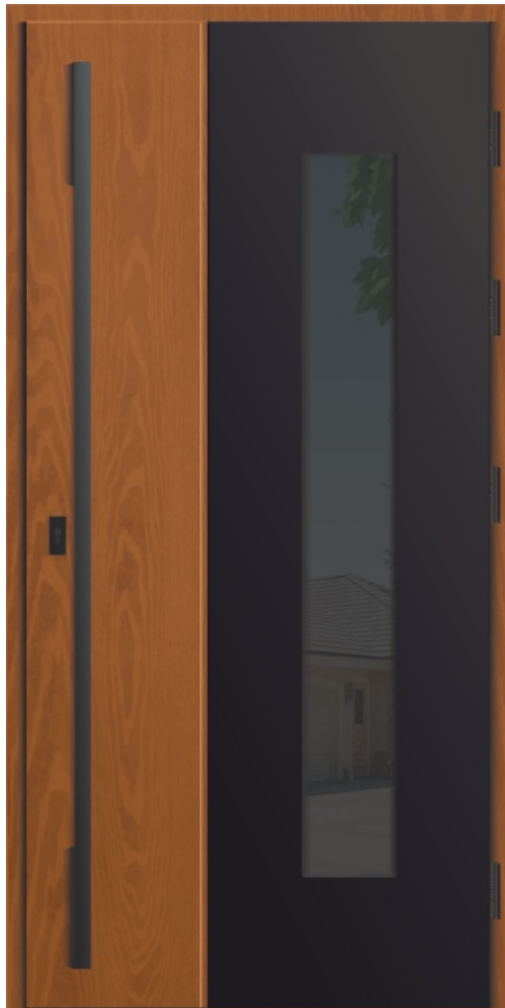

STANDARD ACCESSORIES

Standard fittings for complete external doors from the VISION line:

75 mm thick composite door leaf with wood-like Real Wood surface structure on both sides

optionally with a SMOOTH surface, at extra charge;

optionally at extra charge: in any combination of both surfaces;

90mm x 68mm composite door frame

complete doors finished with the highest quality varnish in the RAL palette or in one of several wood-like decors,

optionally without extra charge with the PEARL, GALAXY or SAND effect,

optional at extra charge: finished in several pre-configured colors;

low aluminium threshold with a thermal break,

optional with extra charge with a system of warm sub-threshold profiles;

three or four 3D adjustable hinges with increased burglary resistance, with covers in the color of the fittings;

anti-burglary bolt system;

three-point anti-burglary FUHR lock, bolted with a handle handle, cylinder lock or automatic;

a set of adjustable stainless steel latches;

double, perimeter sealing system;

wind-stop seal – an additional seal in the door sill;

version with glazing: three-pane glazing with a warm frame system

The price of the door includes one of many patterns of decorations from groups: 1, 2 or 3;

optionally at extra charge: decorated stained glazing from group 4.

*Anti-burglary class RC2 according to the European standard PN-EN 1627 - optional, at extra charge

The price of the door includes a set of dedicated installation consoles.

anti-burglary class



optional

**do not require
an overhang**

composite door frame

*Ask your dealer for details.





ARCTIC PLUS LINE

 **75 mm**
door leaf thickness

 Ud from
0,58 W/m²K*
thermal insulation

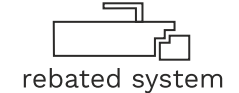
rebated system



STANDARD ACCESSORIES

Standard fittings for complete external doors from the ARCTIC PLUS line:

- 75 mm thick composite door leaf with wood-like Real Wood surface structure on both sides
optionally with a SMOOTH surface, at extra charge;
optionally at extra charge: in any combination of both surfaces;
- PVC 85 mm door frame, six-chamber, class A Plus with identical surface for the leaf;
- complete doors finished with the highest quality varnish in the RAL palette or in one of several wood-like decors,
optionally without extra charge with the PEARL, GALAXY or SAND effect,
optional at extra charge: finished in several pre-configured colors;
- low aluminium threshold with a thermal break,
optional with extra charge with a system of warm sub-threshold profiles;
- three or four 3D adjustable hinges with increased burglary resistance, with covers in the color of the fittings;
- anti-burglary bolt system;
- three-point anti-burglary lock, bolted with a handle, cylinder lock or automatic;
- a set of adjustable stainless steel latches;
- triple, perimeter sealing system;
- wind-stop seal – an additional seal in the door sill;
- version with glazing: three-pane glazing with a warm frame system;
- The price of the door includes one of many patterns of decorations from groups: 1 or 2;
optionally at extra charge: decorated stained glazing from group 3 or 4.
- *Anti-burglary class RC2 according to the European standard PN-EN 1627 - optional, at extra charge
- The price of the door includes a set of dedicated installation consoles.

anti-burglary class



optional

**do not require
an overhang**

PVC door frame



*Ask your dealer for details.

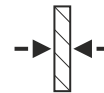

ARCTIC LINE

 **65 mm**
door leaf thickness

 Ud from
0,70 W/m²K*
thermal insulation

rebated system



STANDARD ACCESSORIES

Standard fittings for complete external doors from the ARCTIC line:

65 mm thick composite door leaf with wood-like Real Wood surface structure on both sides
optionally with a SMOOTH surface, at extra charge;
optionally at extra charge: in any combination of both surfaces;

PVC 85 mm door frame, six-chamber, class A Plus with identical surface for the leaf;

Complete doors finished with the highest quality varnish in the RAL palette or in one of several wood-like decors,
optionally without extra charge with the PEARL, GALAXY or SAND effect,
optional at extra charge: finished in several pre-configured colors;

Low aluminium threshold with a thermal break,
optional with extra charge with a system of warm sub-threshold profiles;

Three 3D adjustable hinges with increased burglary resistance, with covers in the color of the fittings;

Anti-burglary bolt system;

Three-point anti-burglary strip lock bolted with a handle or cylinder lock,
optionally at extra charge: automatic locking;

A set of adjustable stainless steel latches;

Double, perimeter sealing system;

Wind-stop seal – an additional seal in the door sill;

Version with glazing: three-pane glazing with a warm frame system;

The price of the door includes one of many patterns of decorations from groups: 1 or 2;
optionally at extra charge: decorated stained glazing from group 3 or 4.

*Anti-burglary class RC2 according to the European standard PN-EN 1627 - optional, at extra charge

The price of the door includes a set of dedicated installation consoles.

anti-burglary class



optional

**do not require
an overhang**

PVC door frame

*Ask your dealer for details.



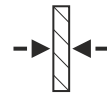

TOP LINE

 **65 mm**
door leaf thickness

 Ud from
0,70 W/m²K*
thermal insulation

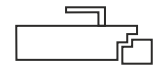
rebated system



STANDARD ACCESSORIES

Standard fittings for complete external doors from the TOP line:

- 65 mm thick composite door leaf with wood-like Real Wood surface structure on both sides;
- PVC 85 mm door frame, six-chamber, class A Plus with wood-like Real Wood surface structure for the leaf;
- complete doors finished with the highest quality varnish in the RAL palette, optionally without extra charge with the PEARL, GALAXY or SAND effect, optional at extra charge: wood-like decors;
- low aluminium threshold with a thermal break, optional with extra charge with a system of warm sub-threshold profiles;
- three 3D adjustable hinges with increased burglary resistance, with covers in the color of the fittings;
- three-point anti-burglary strip lock bolted with a handle or cylinder lock;
- a set of adjustable stainless steel latches;
- double, perimeter sealing system;
- wind-stop seal - an additional seal in the door sill;
- version with glazing: three-pane glazing with a warm frame system;
- The price of the door includes glazing from groups 1 , optionally at extra charge: decorated stained glazing from group 2;
- *Anti-burglary class RC2 according to the European standard PN-EN 1627 - optional, at extra charge
- The price of the door includes a set of dedicated installation consoles.

anti-burglary class



optional

**do not require
an overhang**

PVC door frame



*Ask your dealer for details.



The world's first, unique combination of a door leaf with a composite frame has properties that are unavailable in traditional solutions.

The whole product is made of composite materials. Both sides are flush with the frame, stable, ultra-warm, in an unlimited catalog of solutions. Only available in the ULTIMATE line.

U ULTIMATE

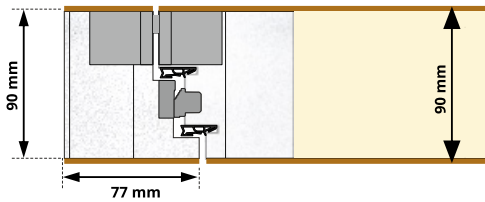

V VISION

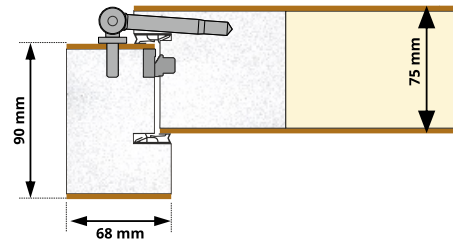

A solid multi-layer construction ensures stability of the door leaf and anti-burglary protection. The door leaf cladding is made of the highest quality fiberglass reinforced composite panels, resistant to scratches and damage.

The highest quality varnishes in any RAL colour, or in one of many wood-like decors combined with the total moisture resistance of composite doors make them much more resistant than traditional doors.

A composite door leaf has a specially reinforced structure, preventing deformation. It is resistant to moisture and mechanical damage. Only composite door leaves consistently maintain the highest quality for decades without the need for special maintenance and varnishing.

The waterproof composite frame protects the inside of the door leaf against moisture, and the CFC-free PU foam insulation with specially designed parameters for the composite door system provides excellent protection against heat loss.

Our silicone seals specially designed for composite doors guarantee the highest protection against heat loss around the entire perimeter and provide high closing comfort.

Innovative six-chamber PVC a-class door frame with real wood or smooth surface.

PVC profiles are resistant to moisture, perfectly insulate from cold and require no maintenance. The system of extensions, connectors and clamps provides the possibility for any frame configuration.

AP ARCTIC PLUS

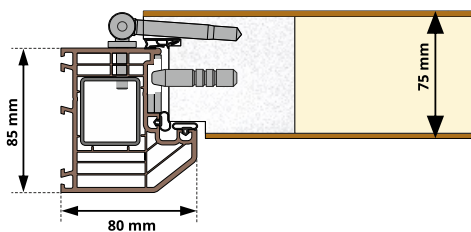

A ARCTIC

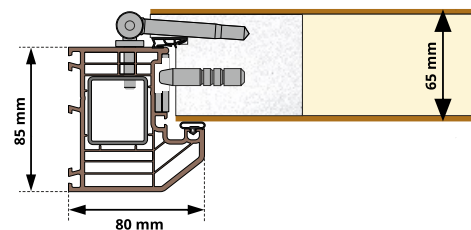

T TOP

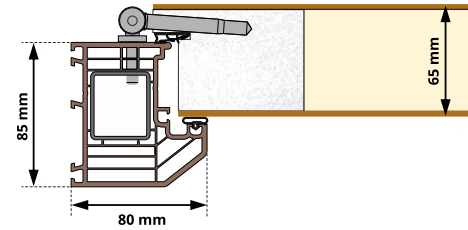



Time for a good choice

Complete, compare and choose the best solution.

PROPERTIES		ULTIMATE	VISION	ARCTIC PLUS	ARCTIC	TOP	OFFER OF COMPANY X
Thermal insulation according to the European standard PN-EN 14351		from 0,49 Wm ² /K	from 0,53 Wm ² /K	from 0,58 Wm ² /K	from 0,70 Wm ² /K	from 0,70 Wm ² /K	
Anti-burglary class according to the European standard PN-EN 1627		RC2 or RC3 (option)	RC2 (option)	RC2 (option)	RC2 (option)	RC2 (option)	
Full overhang required Periodic maintenance of paint coatings		not required	not required	not required	not required	not required	
Warranty*	Door leaf	up to 25 years	up to 25 years	up to 25 years	up to 25 years	up to 25 years	
	Composite door frame	up to 25 years	up to 25 years	N/A	N/A	N/A	
	PVC door frame	N/A	N/A	up to 20 years	up to 20 years	up to 20 years	
	Varnish coatings	up to 10 years	up to 10 years	up to 10 years	up to 10 years	up to 10 years	
	Other components	up to 3 years	up to 3 years	up to 3 years	up to 3 years	up to 3 years	
Composite door leaf – thickness in mm		90 mm	75 mm	75 mm	65 mm	65 mm	
PVC door frame - 6-chamber, A+ class		N/A	N/A	S	S	S	
Composite door frame		S	S	N/A	N/A	N/A	
Real Wood surface (wood-like)		S	S	S	S	S	
SMOOTH surface		O	O	O	O	N/A	
Varnishing in wood-like decors		S	S	S	S	O	
Multi-coloured varnishing		O	O	O	O	N/A	
Doors in non-standard sizes		O	O	O	O	N/A	
Doors according to customized design and fittings		O	O	O	O	N/A	
Sidelights and top lights available according to custom designs		O	O	O	O	O	
Number of perimeter seals		2	2	3	2	2	
Low 20mm aluminium threshold with thermal break		S	S	S	S	S	
3-point lock with a handle		S	S	S	S	S	
3-point strip lock bolted automatically		S	S	S	O	O	
3-point lock, bolted with a cylinder		S	S	S	S	S	
Strip lock bolted with two cylinder locks		O	O	O	O	N/A	
Adjustable stainless steel lock latches		S	S	S	S	S	
System latch strip in the frame		S	S	N/A	N/A	N/A	
Adjustable 3D hinges in the colour of the fittings		N/A	S	S	S	S	
Anti-burglary bolt system		S	S	S	S	O	
Hidden hinge system		S	N/A	N/A	N/A	N/A	
Glazing with a warm inter-pane frame		4-pane	3-pane	3-pane	3-pane	3-pane	
Decorated stained glazing		S	S	O	O	N/A	

*Check the detailed conditions contained in the warranty.

S - standard; O - option; N/A - not available



ELITE collection

Elite beauty right from the threshold of your home! Indulge in luxury with a door collection that stands out for its flawless and sophisticated design. You'll find cutting-edge decorative patterns, meticulously chosen finishes, and a range of elegant decorations, all paired with the allure of black glass and top-quality hardware. Enter the elite world of VIKKING composite doors. We are waiting there just for you!

The collection is available in the lines:

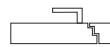

ULTIMATE



VISION



ARCTIC PLUS



04 10 GCL



04 11 GCL



05 08 CL



05 08 GCL



05 10 CL



05 10 GCL



05 11 CL



05 11 GCL



10 01 GCL



CRYSTAL collection

A story written in glass! In the CRYSTAL collection, this material plays the main role. Glazing enthusiasts will appreciate this! Our advanced technology enables us to make doors with "step" glazing, where the outer glass is larger and extends beyond the inner layers, painted in any color you choose, for a striking and unique appearance. CRYSTAL-ic beauty now in your home!

The collection is available in the lines:



UTIMATE



VISION



ARCTIC PLUS



04 01 GC



04 02 GC



04 03 GC



10 01 GCM



10 02 GC



10 03 GC



10 12 GC



10 13 GCM

i Did you know?

You decide about the size, fittings, colors and decorations of your composite doors. We will handle the rest with the utmost care and the commitment of our experts.



VINTAGE collection

We combine tradition with modernity! Did you know that every VIKKING composite door can be completely unique? Models in this collection offer a mix of detailed craftsmanship and versatile style. Here you will find doors suitable for both modern and traditional architecture.

The VINTAGE collection - is a realm of decorations limited only by imagination with slats, which we configure according to your expectations. Vertical layout; horizontal; hexagonal, mixed layout? We are here to fulfill your dreams! Dream of a standout feature for your home's entrance? VINTAGE is just for you!

The collection is available in the lines:



ULTIMATE



VISION



ARCTIC PLUS



02 11 GL



02 11 L



02 13 GL



03 02 L



03 04 L



03 05 L

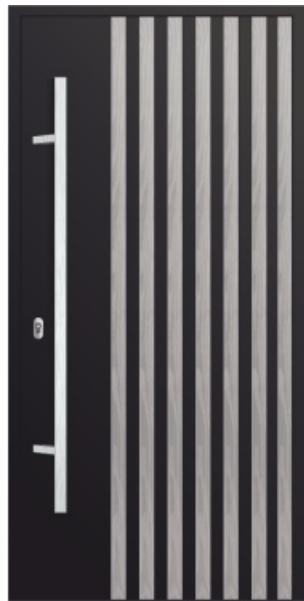

04 10 L



04 11 L



05 01 L



05 06 L



05 07 L



SEE
MORE
DOORS

Line: ULTIMATE Collection: VINTAGE Model: 04 11 L



05 08 GL



05 08 L



05 09 GL



05 09 L



05 10 GL



05 10 L



05 11 GL



05 11 L



05 15 L



10 07 GL



INSPIRO collection

Get inspired with us! VIKKING is the undisputed pioneer of the personalization of exterior doors. Thousands of models that have been created from the projects, visions, and passions of our clients. The surrounding world provides inspiration for innovative exterior doors that are, after all, a feature of the character of our interior. The INSPIRO collection therefore includes full models or with glazing.

Right here, you will also find doors with inlays that allow for inspiring combinations of colors, decorations, and applications. All this is just part of our ideas. We are waiting for your inspirations!

The collection is available in the lines:



UTIMATE



VISION



ARCTIC PLUS



04 01 i



04 03 i



04 04 i



04 05 i



04 06 i



04 07 i



04 08 i



04 12 Gi



04 12 i



05 05 Mi1



Online door configurator

Configure your dream composite doors yourself whenever you want, without leaving your home!

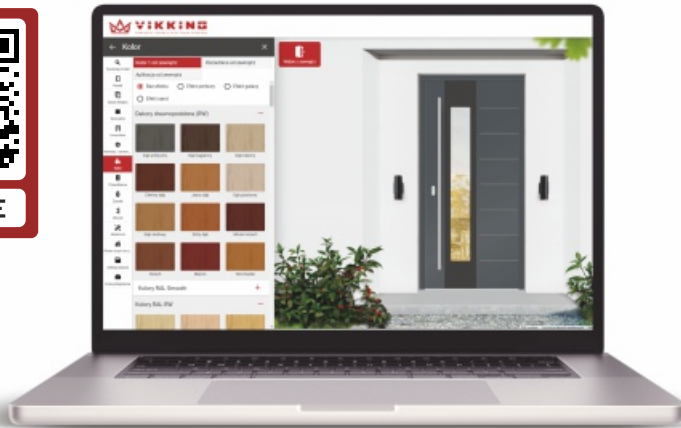

NEW 2024



05 10 Mi1



05 11 Mi1



05 12 Mi1



06 12 GMi



06 12 Mi1



06 13 GMi



06 13 Mi1



07 05 GMi



07 05 Mi1



07 05 Mi2



08 17 GMi

i Did you know?

Composite doors are made only of materials that protect against the loss of valuable energy. And that means significant savings in home heating!



TREND collection

VIKKING shapes new trends! Our R&D team designs collections that reflect current trends. The TREND collection mixes styles and introduces unique decoration techniques exclusive to VIKKING. Composite doors come with customizable glazing in various designs, colors, and sizes. Modern black in hardware and applications? Or maybe one of the many decors from the RAL palette? Set new trends with us!

The collection is available in the lines:

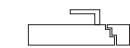

ULTIMATE



VISION



ARCTIC PLUS

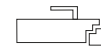

ARCTIC

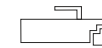

TOP



03 01 GM1



03 07 GM1



04 01 GM1



04 02 GM1



04 03 GM1



04 04 GM1



04 06 GM1



04 07 GM1



04 08 GM1



05 02 GM1



05 03 GM1



05 04 GM1



05 13 GM1



05 14 GM1



05 15 GM1



05 16 GM1



09 01 GF1



09 02 GF1

i Did you know?

Decide if your door will have a Real Wood-like surface or a SMOOTH surface.



09 03 GM1



09 04 GM1



09 05 GM1



10 01 GFM



10 02 GF1



10 03 GF1



10 04 GM1



10 05 GFM



10 06 GF1



10 08 GF1

42



Line: ULTIMATE Collection: TREND Model: 04 06 GM1



i Did you know?

All the doors can be varnished in two or even three colors! Feel the magic of colors, only the composite doors are available without any limitations, in the full range of colors.



10 09 GM1



10 10 GFM



10 11 GM1



10 11 GF1



10 13 GFM



10 14 GM1



10 15 GM1



10 16 G



FUTURE collection

The future is now! Discover the collection that sets the framework for the future. The FUTURE collection includes energy-efficient composite door models featuring original glazing from VIKKING's own glass studio. Choose any applications or inlays with modern shapes to give your dream doors a unique and original look. Looking for distinctive doors that answer to a changing future? The FUTURE collection is for you!

The collection is available in the lines:



UTIMATE

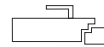

VISION



ARCTIC PLUS



ARCTIC



06 01 GM1



06 02 GM1



06 03 GM1



06 09 GM1



06 11 GM1



06 12 GM1



06 13 GM1



07 01 GM1



07 02 GM1



07 03 GM1



07 04 GM1



07 05 GM1



08 01 GMi



08 02 GMi



08 03 GMi



08 04 G1



08 04 GFM



08 05 GM1



08 06 GF1



08 07 GF1



08 08 GF1



08 09 GM1



08 10 GF1



08 11 GMi



08 12 GF1



08 13 GFM



08 14 GM1



08 15 GM1



08 16 GF2



08 16 GFM



VARIANT collection

Which variant will you choose? When building or renovating your luxurious dream home, we must make choices among many available options. Let's choose the best solutions for you and your family together! Models from the VARIANT collection offer hundreds of decorative variants, both in colour and in the wing decorations perfected with precision milling, available one-sided or optionally also on the interior side.
Which variant do you choose?

The collection is available in the lines:



ULTIMATE



VISION



ARCTIC PLUS

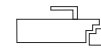

ARCTIC

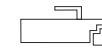

TOP



01010



03 01 M



03 02 M



04 04 M



03 05 M



03 06 M



04 02 M



04 03 M



04 04 M



03 07 M



04 01 M



04 06 M



04 07 M



04 08 M



04 09 M

i Did you know?

Composite doors are available in several dozen sizes in standard versions. On request, they can be produced in any size, up to 2450 mm, and a wide selection of complementary profiles and bands ensure that each solution is comprehensive.



05 01 M



05 02 M



DOOR CONFIGURATOR



VIKKING.EU



05 03 M



05 04 M



05 05 M



05 06 M



05 07 M



05 08 M



05 09 M



05 10 M



05 11 M



05 12 M



05 13 M



05 14 M



05 15 M



05 16 M

i Did you know?

Thanks to the use of fiberglass, composite doors do not require tedious and frequent maintenance. They are unbreakable, and their unsurpassed durability ensures security for generations.



05 18 M



05 17 M



06 01 M



i Did you know?

All RAL colors are also available without additional charges with the PEARL, GALAXY or SAND effect . Don't forget to mark it in your order!



06 02 M



06 13 M



07 01 M



07 02 M



07 03 M



07 04 M



07 05 M



07 06 M



CLASSIC collection

Enter the world of tradition and eternal elegance with us!

The CLASSIC collection is the timeless beauty of composite doors. What distinguishes this collection is the subtle milling, which is a decorative element of the wing. They give the composite doors from the CLASSIC collection an individual cut that emphasizes the character of your home. All models from the CLASSIC collection come in various oak grain finishes. The collection includes designs with glass features and solid ones that adhere to classic beauty standards. Open your doors to the elegance of CLASSIC style!

The collection is available in the lines:



ULTIMATE



VISION



ARCTIC PLUS



ARCTIC

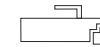

TOP



01010



0201GM1



0201M



0202M



0203GM1



0203M



0204GM1



0204GM2



0204M



0205M



02 06 M



02 07 M



02 08 GM1



02 08 M



02 09 GM1



02 09 M



02 10 GM1



02 10 M

i Did you know?

Composite doors do not require an overhang and do not have restrictions in terms of their proximity to heating devices.



i Did you know?

Your composite door can have an intelligent control system and be integrated with your Smart Home installation. Define your priorities, we will take care of the rest.



0211 GM1



0211 M



0212 GM1



0212 M



0213 GM1



0213 M



0214 M



0215 M



Line: VISION Collection: VINTAGE Model: 05 15 L



LED lighting in composite doors

Try something new and add an interesting light effect to your front doors. A soft glow coming from door's pull or glazing packages provides soft illumination of the entrance area. And if you want something even more unique, we also offer composite doors with LED lighting on the door leaf!

LED IN DOOR LEAF



LED STRIP IN A PULL



A BRIGHT ACCENT IN YOUR HOME



Full RAL color palette



RAL 9005
PEARL EFFECT



RAL 9005
GALAXY EFFECT

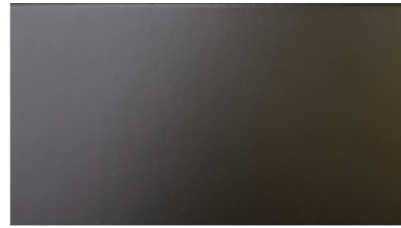

RAL 9005
SAND EFFECT

SPECIAL EFFECTS

GALAXY, PEARL and SAND effect coatings can be used on the SMOOTH surface in all colors from the RAL palette.

DON'T FORGET TO MARK THIS IN YOUR ORDER!

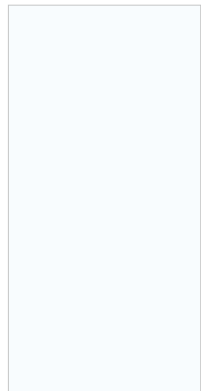

RAL 9016

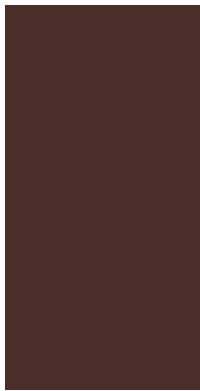

RAL 8017



RAL 7016



RAL 7043

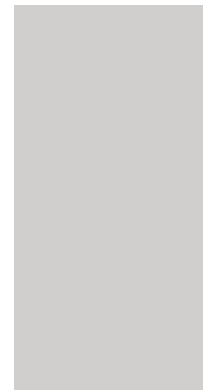

RAL 7047



RAL 7040

RAL COLORS IN STANDARD

Composite doors are available in any color from the RAL palette.

Composite doors are varnished in any configuration and color combination (divided into external and internal sides) and in several colors on each side. Wood-like colors and RAL colors can be combined with each other.



RAL 3004



RAL 9023

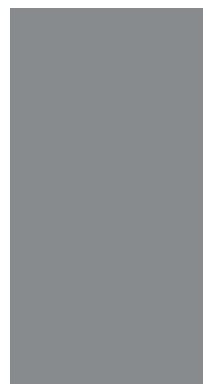

RAL 7046



RAL 7036



RAL 7021

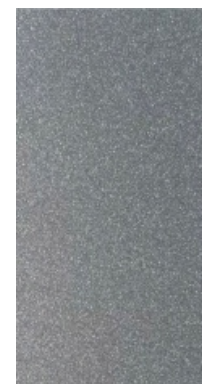

Quartz
special color





Wood-like decors

For lovers of precious wood colors, we offer one of many decors created by hand by craftsmen of the highest qualifications. The unique varnishing technology using a traditional patinating method gives it a dignified appearance character of composite doors.

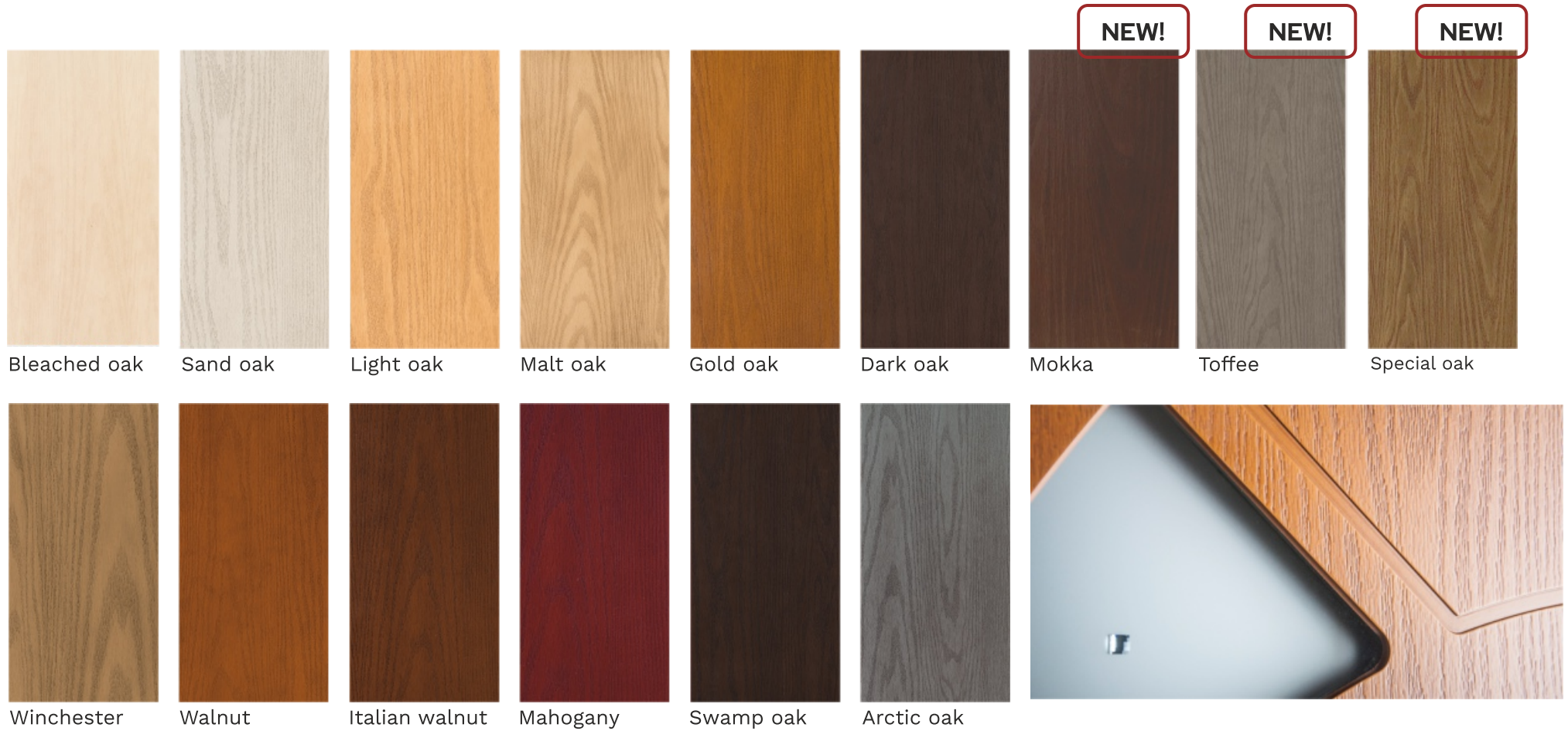



Remote controlled doors

CHOOSE COMFORT AND SECURITY

Your composite door can be equipped with an intelligent control system and integrated with your Smart Home installation. Don't worry about carrying keys around any more and open your doors in any way you like. You can grant access to any family member. You have full control. Define your priorities, we will take care of the rest.



INSTINCT BY MACO - The locking system

The lock with the horse-head mechanism locks in the direction of door movement, ensures extremely high contact pressure and locks and unlocks the door very quickly and quietly. INSTINCT locks mechanically-automatically as standard and uses the weight of the door for a secure contact pressure. Access authorisation can be easily setup with the App and individually for each person, with one-time access also possible spontaneously on the go.

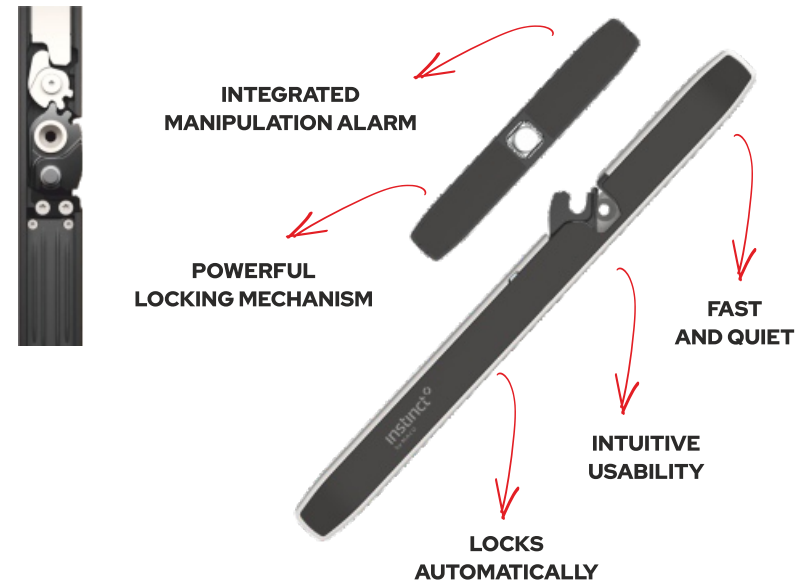

Keyboard Sorex Unilock

A solution offering the possibility of opening the door using a fingerprint, a keypad with a code, via bluetooth devices (e.g. a smartphone or tablet) and an RFID carrier. Keyboard allows full customization and control using a smartphone application, allows you to add users and assign them permanent, temporary, one-time or cyclical access.



TEDEE locking technology

Tedee locking technology gives you complete remote lock steering. Wherever you are, having a smartphone with internet access, you may check your lock status, see if it is opening or closing. You also can grant access to anyone in that way.



Smart solutions for your convenience



E-key fingerprint scanner dLine

The system with the ekey dLine fingerprint reader is managed via smartphone or tablet. The new ekey bionyx app developed especially for this purpose can be operated in Comfort mode mode via the Internet or in Local mode on site via radio.

› The door becomes smart

Additional functions and access to the smart home world

› New sensor technology

Touch operation in ekey quality

› The door design is in the foreground

The fingerprint scanner has the smallest possible construction, and design elements can be adapted to the door design

Pulls with electronics mounted in the leaf and connected.

Electronics available in selected models.



Microswitch in the pull

(does not apply to bow pulls)
for use with an electric strike
or a motorized lock

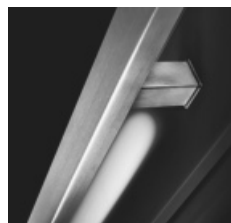

"LED" strip lighting

dedicated to pulls.
Includes a complete installation
with 2 pin. connector plug; leaf - frame
does not apply to bow pulls.



› Uniform operating concept

All new ekey products are managed via an app

› Future-proof system

Expandable at any time with new features and devices

› Plug & play system

The ekey dLine is ready to plug in



dLine black



dLine inox

i Did you know?

Pull can be equipped with functionalities facilitating the use of the door. Discreet LED lighting, a fingerprint reader or button releasing the catch in the door frame – these are solutions that increase comfort of use.



Glazing packages

MORE LIGHT IN YOUR HOME

Glazing packages in composite doors have super warm glazing frames. This significantly improves their energy efficiency and acoustic comfort. We make glazing packages and stained glass decorations in our own studio, nothing is impossible for us.

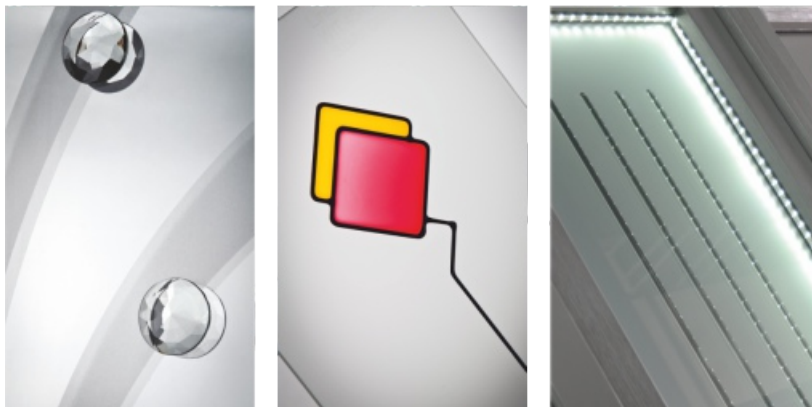

DECORMAT



BEWEL



SANDBLASTED



ANTISOL



ONE-WAY MIRROR



DECORMAT



TERMOFLOAT



REFLEX



See more
in the Stained
Glass Catalog





Groups of glazing packages

Only composite doors offer the possibility to choose glazing decorations from the our wide range with any glass configuration.

Group of decorations	G1 Group 1	G2 Group 2 - Standard	G3 Group 3 - Premium	G4 Group 4 - Hand Made
Types of glass and decorations	<p>Glazing packages - not decorated (no extra charges)</p> <p>Types of glass:</p> <ul style="list-style-type: none"> - termofloat - float - decormat - ornament <p>Options at extra charge</p> <ul style="list-style-type: none"> - reflex (brown or grey) tempered - antisol (brown, grey or dark graphite) tempered - tempered glass - P2 - P4 (not available in arched glazing) 	<p>Decorated glazing packages</p> <p>Technology:</p> <ul style="list-style-type: none"> - resin decoration (resin contour + filling) - engraved <p>Types of glass:</p> <ul style="list-style-type: none"> - the same as in group 2 and: - one-way mirror 	<p>Decorated glazing packages with:</p> <ul style="list-style-type: none"> - bevel - fusing - inox decoration <p>Technology:</p> <ul style="list-style-type: none"> - the same as in group 2 and: - ceramic varnishing <p>Types of glass:</p> <ul style="list-style-type: none"> - the same as in group 2 	<p>Decorated glazing packages with:</p> <ul style="list-style-type: none"> - bevel - fusing - inox decoration <p>Technology:</p> <ul style="list-style-type: none"> - the same as in group 3 and: - lead strips applied by hand* - custom orders <p>Types of glass:</p> <ul style="list-style-type: none"> - the same as in group 2

Standard glass thickness: 4 mm or 6 mm

* Lead strip: gold, silver or black.



Sidelights

PERFECTLY MATCHED TO YOUR HOUSE

Sidelights and transom lights are a great idea for more daylight in the interior. They are perfect for full doors.

The sidelights can be filled with:

- ▶ glazing with any decorations
- ▶ composite panel

In the ULTIMATE line, thanks to the combination with a composite door frame, the sidelight system is constructed without visible connecting profiles.

In the remaining lines, the sidelight construction is based on a system of static connectors ensuring stability of the structure.



- U** ULTIMATE line
- V** VISION line
- AP** ARCTIC PLUS line
- A** ARCTIC line
- T** TOP line

Cross-section of leaf and sidelight combination ULTIMATE line

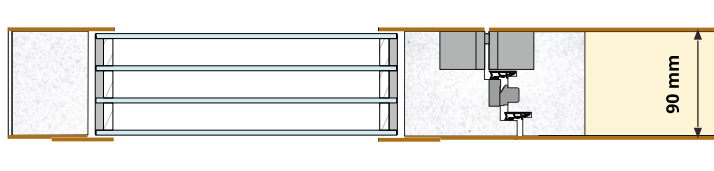

Cross-section of leaf and sidelight combination VIOSION line

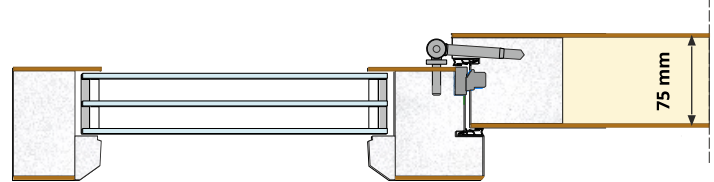

Cross-section of leaf and sidelight combination ARCTIC PLUS line

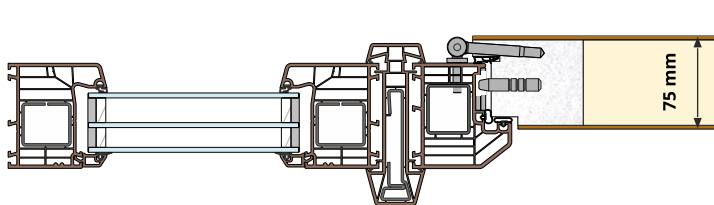
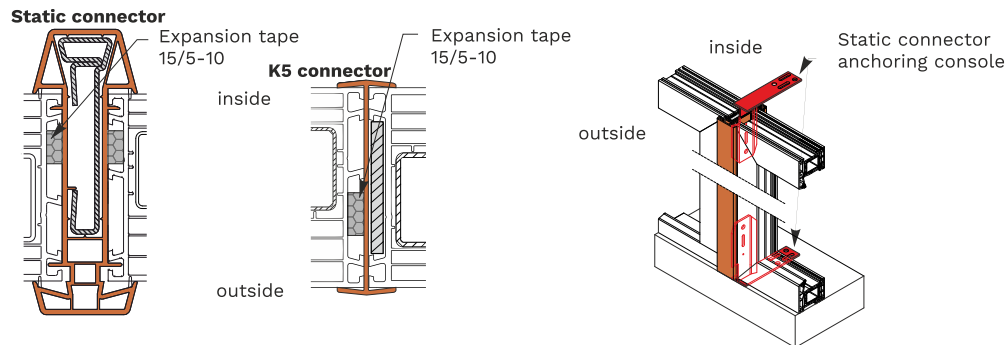

Diagram of connectors used in the lines: AP A T



TILT AND TURN SIDELIGHT BY VIKKING

When choosing composite doors, we recommend using a tilt-and-turn sidelight.

This is a completely innovative technology that provides additional ventilation in your home.

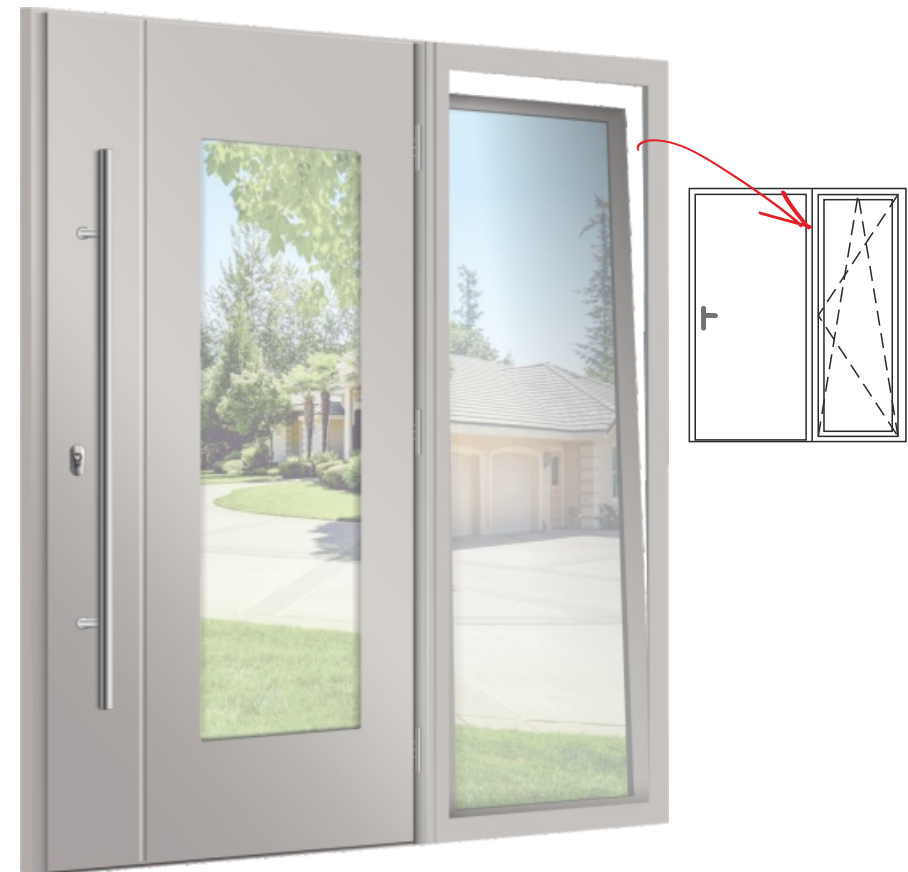

*Available only in the ARCTIC PLUS and ARCTIC lines. Optional at extra charge.



Portals and sidelights

Line	Side portals or sidelights		Top portals or toplights		Side or top portals	Sidelights or toplights			
	Width (every 10 mm)	Height	Width	Height (every 10 mm)		Composite panel filling	Filling with glazing from the 1 group	Filling with glazing from the 2 group or with a one-way mirror	Filling with glazing from the 3 group
ULTIMATE	from 300 mm to 850 mm	Height equal to the height of the door H1;	Width equal to the width of the door S1 - up to max. door width from the selected line;	from 300 mm to 850 mm	Available	Not available	Available	Available	Available
VISION					Available	Available	Available	Available	
ARCTIC PLUS	from 250 mm to 850 mm	above 2180 mm extra charge 20%	above this width top portals and toplights are priced according to side portal and sidelights prices;	from 250 mm to 850 mm	Not available	Available	Available	Available	Optional at extra charge
ARCTIC					Not available	Available	Available	Optional at extra charge	
TOP					Not available	Available	Optional at extra charge	Not available	

- Available
- Optional at extra charge
- Not available

Portals and sidelights larger than the maximum standard dimensions - optional at extra charge.
 Note: in the TOP, ARCTIC, ARCTIC PLUS door lines the dimension and price of the sidelight and top light include a static connector and a console set.



Dimensions of VIKKING composite doors

Door sizes available in 10 mm steps			WIDTH S1			
			mini	standard	XXL	
			870 - 960 mm	970 - 1070 mm	1080 - 1170 mm	1180 - 1220 mm
HEIGHT H1	mini	1980 - 2020 mm				
	standard	2030 - 2180 mm				
	XXL	2190 - 2450 mm				

- Doors in the TOP line are available only in standard sizes
- XXL sizes available for an additional fee (not available in the TOP line)
- XXL width range available only for the ULTIMATE line

Recommended dimensions of the opening in the wall H2 x S2 H2 = H1 + 20 mm
 S2 = S1 + 30 mm

Internal dimensions of the door frame H0 x S0

ULTIMATE	H0 = H1 - 104 mm
	S0 = S1 - 168 mm
VISION	H0 = H1 - 88 mm
	S0 = S1 - 136 mm
ARCTIC	H0 = H1 - 100 mm
	S0 = S1 - 160 mm

Non-standard sizes of doors, portals and sidelights are available optionally, pricing on request. Optional frame extensions as well as a system of banding strips and grilles are available for all door models and sidelights. Do you need technical support, a visualization or an individual design? Contact us at: wyceny@vikking.eu



Handles

NEW!



Markiz* handle double-sided

- ▶ inox
- ▶ black



Markiz* handle with a divided plate for the cylinder

- ▶ inox
- ▶ black



Mars** handle with a divided plate for the cylinder

- ▶ F8 black
- ▶ F6 inox brushed



Mars Flex** handle with a divided plate with cylinder protection

- ▶ F8 black
- ▶ F6 inox brushed



Mars** Handle-knob with a divided plate for the cylinder

- ▶ F8 black
- ▶ F6 inox brushed



Prestige handle, class III double-sided

- ▶ F6 inox brushed



Prestige plate, class III***

- ▶ F6 inox brushed



Prestige handle, class III with cylinder protection -double-sided

- ▶ F8 black
- ▶ F6 inox brushed



Prestige plate, class III*** with cylinder protection - double-sided

- ▶ F8 black
- ▶ F6 inox brushed



Haga Plus handle - double-sided

- ▶ F8 black
- ▶ F6 inox brushed



Haga Plus handle-knob

- ▶ F8 black
- ▶ F6 inox brushed



Haga Plus plate***- double-sided

- ▶ F8 black
- ▶ F6 inox brushed

*Not available in the top and arctic line

**Only available in the ULTIMATE line

***Applies to doors equipped with an additional upper lock



Lord door handle reinforced with concealed screws double-sided

- ▶ white
- ▶ brown
- ▶ F9 satin nickel
- ▶ stainless steel



Baron door handle reinforced with concealed screws double-sided

- ▶ white
- ▶ brown
- ▶ black
- ▶ F9 satin nickel
- ▶ stainless steel



Baron or Lord plate, oval or rectangular (double-sided) dedicated to an additional upper lock

- ▶ white
- ▶ brown
- ▶ black
- ▶ F9 satin nickel
- ▶ stainless steel



Odin handle, class III double-sided

- ▶ inox



Odin handle-knob, class III

- ▶ inox



Odin plate, class III double-sided

- ▶ inox



Lord door handle reinforced with concealed screws with cylinder protection - double-sided

- ▶ F9 satin nickel



Baron door handle reinforced with concealed screws with cylinder protection - double-sided

- ▶ F9 satin nickel



Baron or Lord plate with cylinder protection from the external side (double-sided) dedicated to an additional upper lock

- ▶ F9 satin nickel

ONE-SIDED HANDLES DEDICATED TO INOX AND BLACK VARNISHED PULLS



Markiz handle one-sided
Two-sided upper Markiz plate
▶ inox
▶ black



One-sided **Solo** handle with one-sided plate dedicated to pulls AMSTERDAM
Two-sided upper Solo plate
▶ F8 black
▶ F6 inox brushed



One-sided **Solid** handle with one-sided plate dedicated to pulls AMSTERDAM
Two-sided upper Solid plate
▶ F8 black
▶ F6 inox brushed



Baron handle one-sided for pulls
▶ F9 satin nickel
▶ black



Lord handle one-sided for pulls
▶ F9 satin nickel



Baron plate one-sided for door handles and pulls oval or rectangular
▶ F9 satin nickel
▶ black



One-sided oval plate with cylinder protection dedicated to inox door handles and pulls
▶ F9 satin nickel



Pulls



K1 LONG

K1 long flush pull
one-sided
mounted in the door leaf

width: 155 mm
height: 550 mm

- ▶ inox
- ▶ varnished aluminum in black



KA1

Ka1 aluminum flush pull,
with built-in LED strip
mounted in the door leaf
(power supply must be added)

width: 61 mm
height: 2000 mm

L= 1600 mm
L= 2000 mm

- ▶ varnished aluminum in black

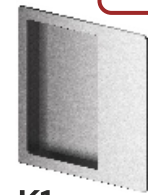

NEW!



K1

K1 flush pull
one-sided
mounted in the door leaf

width: 200 mm
height: 200 mm

- ▶ inox
- ▶ varnished aluminum in black



MONTREAL

MONTREAL one-sided round pull

L= 800 mm
L= 1200 mm
L= 1500 mm
L= 1700 mm

- ▶ black



NEW!

PS21

Ps21 pull
one-sided
80x10 mm

L= 800 mm
L= 1200 mm
L= 1600 mm
L= 2000 mm

- ▶ black

PS21 + PSN01

L= 800 mm
L= 1200 mm
L= 1600 mm
L= 2000 mm } + 50-1200 mm



QA90

Qa90 pull, square tube 40x40
one-sided

L= 800 mm
L= 1000 mm
L= 1200 mm
L= 1400 mm
L= 1600 mm
L= 1800 mm

- ▶ inox
- ▶ varnished aluminum in black
- ▶ other RAL colors on request



PS-W

PS-W pull
one-sided
100x5 mm

L= 1800 mm
L= 2000 mm
L= 2200 mm

- ▶ inox



PS

PS pull
one-sided
100x5 mm

L= 1800 mm
L= 2000 mm
L= 2200 mm

- ▶ inox



LONG C
 LONG-C pull
 L= 1800-2400 mm
 ▶ inox brushed
 ▶ black

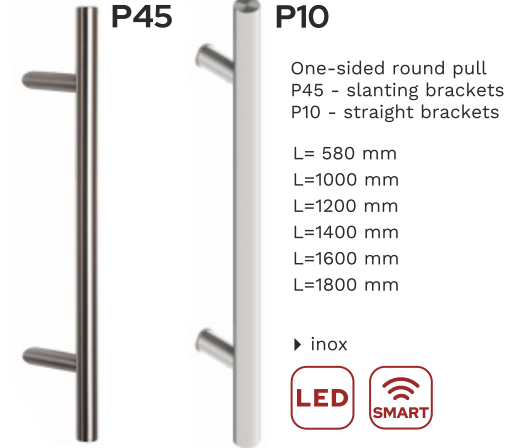

AMSTERDAM
 Amsterdam pull
 one-sided, rectangular
 20x40 mm
 L= 800 mm
 L=1200 mm
 L=1500 mm
 L=1700 mm
 ▶ inox brushed
 ▶ F8 black



OPTIONAL



slanting brackets straight brackets

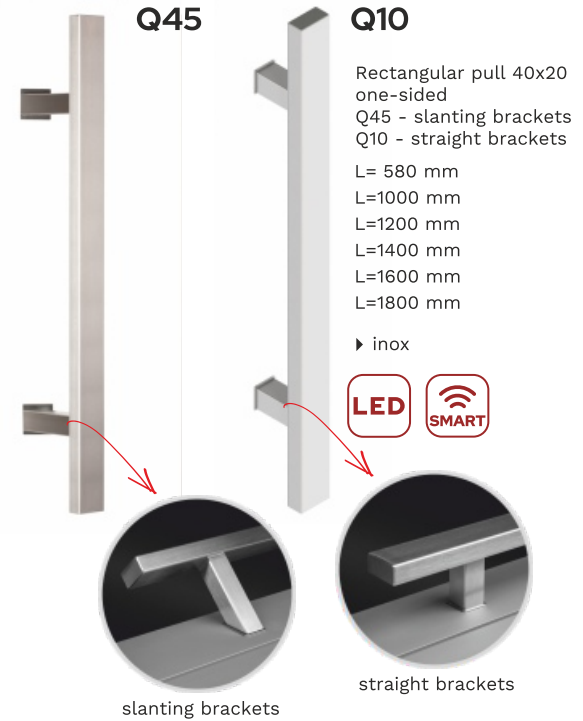



Variants of opening composite doors

Double-sided handle

Door opened on both sides with a handle.

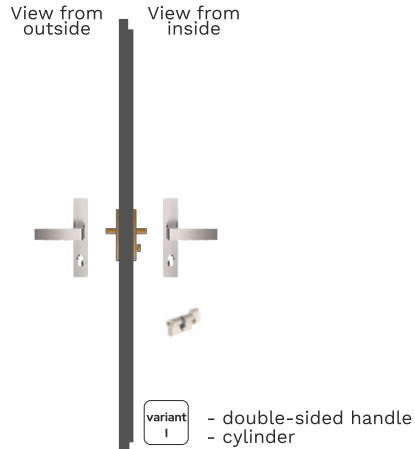

Handle-pull

From the inside: open with a door handle
From the outside: open with a key and pull

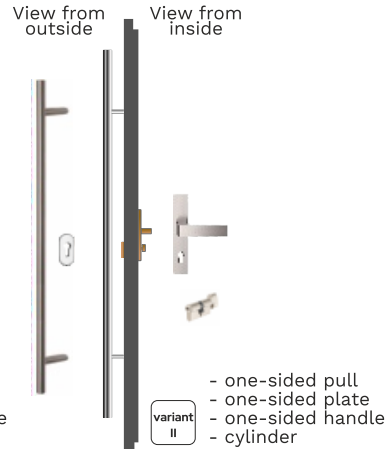

Handle-pull with fixed strike plate

From the inside: open with a door handle
From the outside: during the day: use the door pull;
at night: open using the key and use the door pull. We recommend using a door closer.

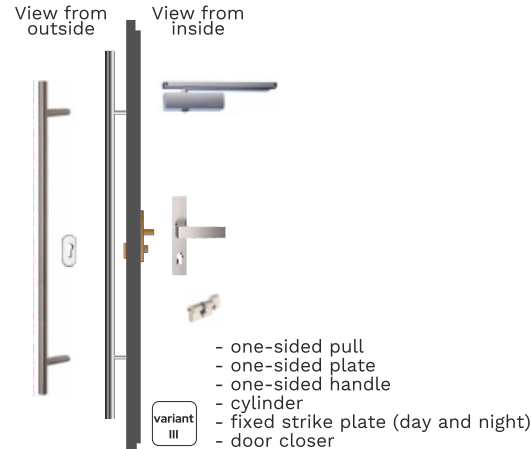

Handle-pull with electric strike

From the inside: open with a door handle
From the outside: during the day: use the door pull;
at night: open using the key and use the door pull; optionally: control using intercom.
We recommend using a door closer.

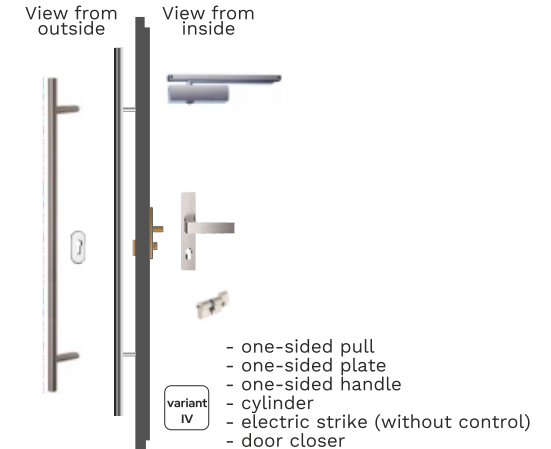

Handle-pull with microswitch

From the inside: open with a door handle
From the outside: press the micro switch in the pull and open the door. We recommend using a door closer.

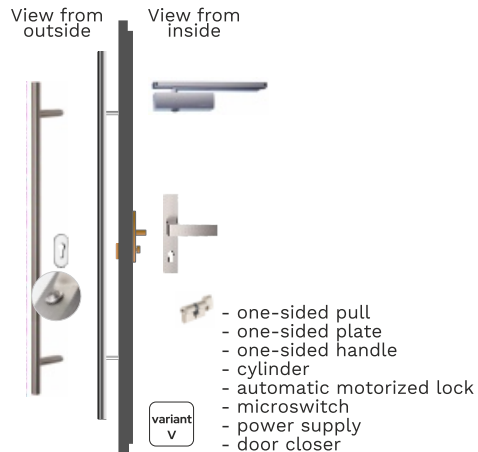

Handle-pull with a fingerprint reader

From the inside: open with a door handle
From the outside: scan your finger on the reader and open the door. We recommend using a door closer.

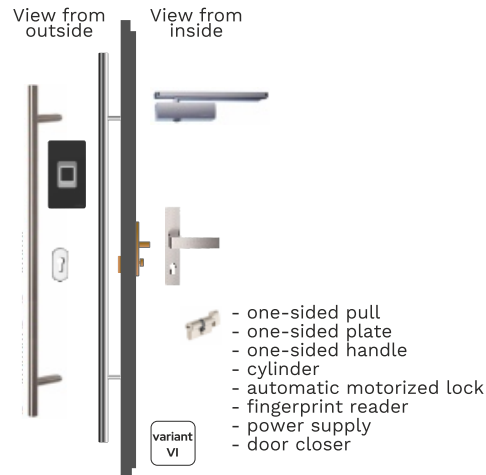

Handle-pull with a Bluetooth keyboard

From the inside: open with a door handle
From the outside: enter the code on the keyboard and open the door. We recommend using a door closer.

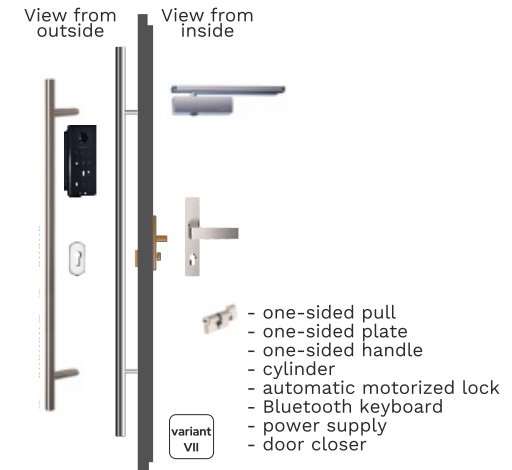



Strip locks and accessories

WE CARE ABOUT YOUR SAFETY

Strip locks for doors in the ULTIMATE and VISION lines

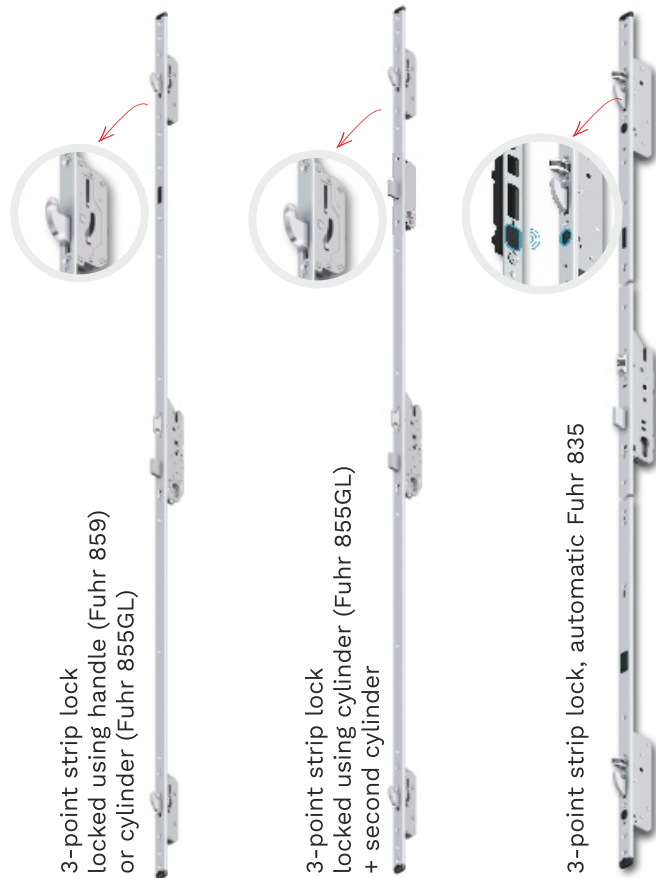

3-point strip lock locked using handle (Fuhr 859) or cylinder (Fuhr 855GL)

3-point strip lock locked using cylinder (Fuhr 855GL) + second cylinder

3-point strip lock, automatic Fuhr 835

Strip locks for doors in the ARCTIC PLUS, ARCTIC and TOP lines

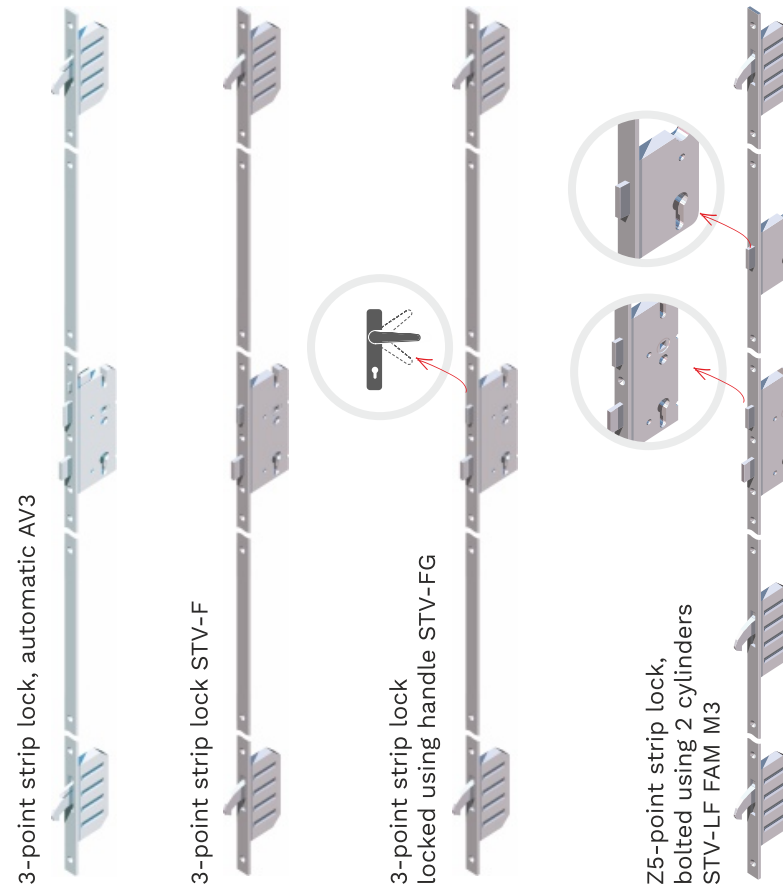

3-point strip lock, automatic AV3

3-point strip lock STV-F

3-point strip lock locked using handle STV-FG

Z5-point strip lock, bolted using 2 cylinders STV-LF FAM M3

Stainless steel strike



Fixed strike plate with day/night function

With electric strikes and fixed strike plates it is recommended to use a door closer that will protect the leaf against opening due to draft.



Cylinders

Cylinders (C class) from the ULTIMATE and VISION lines		
No.	Name	color
1.	Key/key cylinder - C class 	nickel/satin
2.	Key/key cylinder - C class 	black
3.	Key/knob cylinder - C class 	nickel/satin
4.	Key/knob cylinder - C class 	black
5.	One key system cylinder (key/key + key/knob) C class 	nickel/satin
6.	One key system cylinder (key/key + key/knob) C class 	black
Cylinders from the ARCTIC PLUS, ARCTIC and TOP		
7.	Key/key cylinder - standard 	nickel
8.	Key/knob cylinder - standard 	nickel
9.	Key/key cylinder - C class 	nickel
10.	Key/knob cylinder - C class 	nickel
11.	One key system cylinder (key/key + key/knob) C class 	nickel

Closers



- ▶ GEZE BOXER door closer with rail mounted in the door leaf - includes an inox mounting plate
- ▶ Lock for BOXER door closer



- ▶ GEZE TS 3000 door closer with rail - includes an inox mounting plate
- ▶ Opening angle stop for door closer with rail
- ▶ Lock for GEZE 3000 door closer



- ▶ GEZE TS 2000 door closer with arm - includes an inox mounting plate
- ▶ GEZE TS 2000 door closer with locking arm - includes an inox mounting plate



- ▶ GEZE TS 2000 door closer with rail - includes an inox mounting plate
- ▶ Opening angle stop for door closer with rail
- ▶ Lock for GEZE 2000 door closer



MATCHING DIMENSIONS

No.	Name	ULTIMATE	VISION	ARCTIC PLUS	ARCTIC	TOP	unit
1.	XXL size doors height H1 from 2180 mm to 2450 mm width S1 from 1070 mm to 1170 mm	O	O	O	O	N/A	set
2.	PVC frame extension with steel reinforcements decorated or varnished in the color of the frame	15 mm / per side (does not include reinforcements)	N/A	O	O	O	mb
3.		35 mm / per side	N/A	O	O	O	mb
4.		60 mm / per side	N/A	O	O	O	mb
5.		100 mm / per side	N/A	O	O	O	mb
6.	Expanding the composite door frame in the ULTIMATE and VISION lines	20 mm	O	N/A	N/A	N/A	mb
7.		40 mm	O	N/A	N/A	N/A	mb
8.		60 mm	O	N/A	N/A	N/A	mb

LOCKS

No.	Name	ULTIMATE	VISION	ARCTIC PLUS	ARCTIC	TOP	unit
9.	Extra charge for a three-point strip lock with automatic locking	S	S	S	O	O	set
10.	Extra charge for a strip lock bolted with two cylinders	O	O	O	O	N/A	set
11.	Extra charge for a motorized lock with a cable gland	O	O	O	O	N/A	set
12.	Anti-burglary bolts	S	S	S	S	O	set

ELECTRONICS

No.	Name	ULTIMATE	VISION	ARCTIC PLUS	ARCTIC	TOP	jm
13.	Reed switch - door opening sensor	O	O	O	O	O	set
14.	Electric strike - requires the use of a door closer*	N/A	N/A	O	O	O	set
15.	Fixed strike plate - requires the use of a door closer*	O	O	O	O	O	set
16.	Electronic control a motorized lock should be added to the fittings	E-key dLine	O	O	O	N/A	set
17.		Keyboard Sorex UniLock	O	O	O	O	N/A
18.	Tedee locking technology	O	O	O	O	O	set
19.	Power supply for electronic control	O	O	O	O	O	set
20.	Cylinder locking sensor	O	O	O	O	O	set

* Doors with a fixed strike plate, electric strike and/or one-sided pull have, in the standard version, a three-point lock, bolted with a cylinder.



THRESHOLD ADDITIONS

No.	Name		ULTIMATE	VISION	ARCTIC PLUS	ARCTIC	TOP	unit
21.	Sub-threshold PVC profile without steel reinforcement	30 mm	N/A	O	O	O	O	mb
22.		65 mm	N/A	O	O	O	O	mb
23.	Sub-threshold PVC profile with steel reinforcement	30 mm	N/A	O	O	O	O	mb
24.		65 mm	N/A	O	O	O	O	mb
25.	Composite sub-threshold	15 mm	O	N/A	N/A	N/A	N/A	pcs.
26.		30 mm	O	N/A	N/A	N/A	N/A	pcs.
27.	Thermal sub-threshold profile 1 pc. = 1.2 m	70 mm	O	N/A	N/A	N/A	N/A	pcs.
28.		110 mm	O	N/A	N/A	N/A	N/A	pcs.
29.		150 mm	O	N/A	N/A	N/A	N/A	pcs.
30.		200 mm	O	N/A	N/A	N/A	N/A	pcs.
31.		250 mm	O	N/A	N/A	N/A	N/A	pcs.
32.	300 mm	O	N/A	N/A	N/A	N/A	pcs.	
33.	Superfix glue 290/430		O	N/A	N/A	N/A	N/A	pcs.
34.	Automatic door seal		O	O	O	O	N/A	pcs.
35.	"NT" threshold leveling pad		N/A	O	O	O	O	pcs.

SUB-THRESHOLD PROFILES

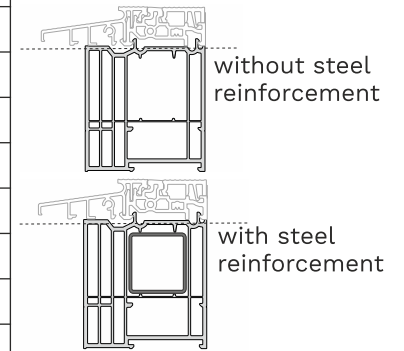

AUTOMATIC DOOR SEAL

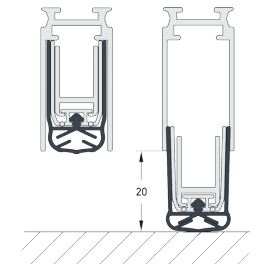

BANDING STRIPS

No.	Name		ULTIMATE	VISION	ARCTIC PLUS	ARCTIC	TOP	unit
36.	30 mm x 8 mm PVC banding strip smooth surface or decorated real wood varnished in the color of the door frame - length adapted to the door size rounded to 0.5 mb upwards		N/A	O	O	O	O	mb
37.	50 mm x 12 mm PVC banding strip smooth surface or decorated real wood varnished in the color of the door frame - length adapted to the door size rounded to 0.5 mb upwards		N/A	O	O	O	O	mb
38.	"LGK" masking strip in the color of the frame L=6 mb smooth surface in the color of the door frame - (available only in the "SMOOTH" surface) length adapted to the door size rounded to 0.5 mb upwards		N/A	O	O	O	O	mb
39.	80 mm x 6 mm composite banding strips (other sizes available on request)		O	O	O	O	O	mb

THRESHOLD LEVELING PAD

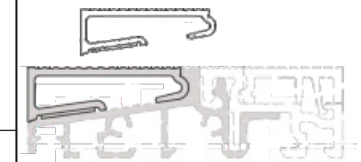

Legend
S-standard version-no extra charge
O-optional at extra charge
N/A-not available



CUSTOM SURFACES

No.	Name	ULTIMATE	VISION	ARCTIC PLUS	ARCTIC	TOP	unit	
40.	SMOOTH surface finish	one-sided	O	O	O	O	N/A	set
41.		two-sided	O	O	O	O	N/A	set
42.	Doors with combined SMOOTH and RW surfaces (on one side of the leaf)		O	O	O	O	N/A	set
43.	SMOOTH surface in ULTIMATE sidelights applies to composite panel filling – PORTAL	one-sided	O	N/A	N/A	N/A	N/A	set
44.		two-sided	O	N/A	N/A	N/A	N/A	set
45.	Varnish with PEARL effect – option without additional charge - available in all lines on RW and SMOOTH surfaces – in RAL colors and wood-like decors GALAXY or SAND coating varnish – option without additional charge – available only on SMOOTH surface and in RAL colors PLEASE NOTE! Precisely specify the type of coating in the order.	doors	O	O	O	O	N/A	set
46.		portals and sidelights	O	O	O	O	N/A	pcs.
47.	Additional charge for varnishing in wood-like decors	doors	S	S	S	S	O	set
48.		portals and sidelights	S	S	S	S	O	pcs.
49.	Additional charge for varnishing in two colors	doors	O	O	O	O	O	set
50.		portals and sidelights	O	O	O	O	O	pcs.
51.	Additional charge for the third and each additional color (additional charge does not apply to KZ and KW frames)		O	O	O	O	N/A	set
52.	Additional charge for varnishing due to the complex division of colors		O	O	O	O	N/A	set
53.	Additional charge for varnishing KZ and KW frames in a different color		O	O	O	O	N/A	set
54.	House door number	inox flush digits–height 140 mm	O	O	O	O	O	1 digit
55.		semi-flush composite board digits–height 140	O	O	O	O	O	1 digit
56.	FL decorative inox strips – flush with the leaf surface (available only in straight lines)	one-sided	O	O	O	O	O	set
57.	FR application from the inside of the leaf – milled decoration		O	O	O	O	O	set
58.	Inox frames - one-sided (RZ)		O	O	O	O	O	set
59.	Inox or composite frames - both sides (RZ + RZ or KZL + KWL)		O	O	O	O	O	set
60.	Inlay – decoration of the door with a semi-flush application from a composite board		O	O	O	O	N/A	set
61.	"LC" inox threshold strip, 90 mm high – other sizes on request.		O	O	O	O	N/A	pcs.



GLAZING AND WINDOW DECORATIONS

No.	Name	ULTIMATE	VISION	ARCTIC PLUS	ARCTIC	TOP	unit
62.	Glazing class P2 or tempered – in the leaf	O	O	O	O	O	set
63.	Glazing class P4 – in the leaf (not available in arched glazing)	O	O	O	O	N/A	set
64.	Glazing class P2 or tempered – in sidelights (min. size calculated at 0.4 m ²)	O	O	O	O	O	m ²
65.	Glazing class P4 – in sidelights (min. size calculated at 0.4 m ²)	O	O	O	O	N/A	m ²
66.	Glazing and stained glass packages in the door leaf see Stained Glass Catalog www.vikking.eu	S	S	S	S	O	group 2 patterns or packages with one-way mirror
67.	Decorations of glazing in sidelights – see table on page 57						group 3 patterns
68.	group 4 patterns - custom designs						
69.	House number – digits on the glazing made using resin technology	O	O	O	O	O	1 digit
70.	LED lighting in the door glazing.* The price includes a complete installation with a contact connector: leaf - frame	O	O	O	O	N/A	the price does not include the power supply see items 72-74
71.	LED lighting in the sidelight glazing						
72.	Power supply (2A) for LED lighting in the door leaf	O	O	O	O	N/A	pcs.
73.	Power supply (4A) for LED lighting in the door leaf and sidelight	O	O	O	O	N/A	pcs.
74.	Power supply (1.67A) for flush-mounted box	O	O	O	O	O	pcs.

OTHER

No.	Name	ULTIMATE	VISION	ARCTIC PLUS	ARCTIC	TOP	unit
75.	Complete double door	O	O	O	O	N/A	set
76.	Anti-burglary grille in high-quality steel door leaf	O	O	N/A	N/A	N/A	pcs.
77.	Illuminated door leaf – LED lighting mounted in the rebate from the bottom of the leaf	O	O	O	O	N/A	the price does not include the power supply, see item 72-74
78.	Extra charge for additional silicone peripheral seal of the leaf (third)						
79.	Door drip, varnished in the color of the door (applies to external doors that open inwards)	N/A	O	O	O	O	pcs.
80.	Extreme door drip in threshold color (anodized aluminum)	N/A	O	O	O	O	pcs.
81.	Extreme Plus door drip in threshold color (anodized aluminum)	N/A	O	O	N/A	N/A	pcs.

EXTREME DOOR DRIP



Legend
 S - standard version-no extra charge
 O - optional at extra charge
 N/A - not available



Professional installation

Door dimensioning diagram

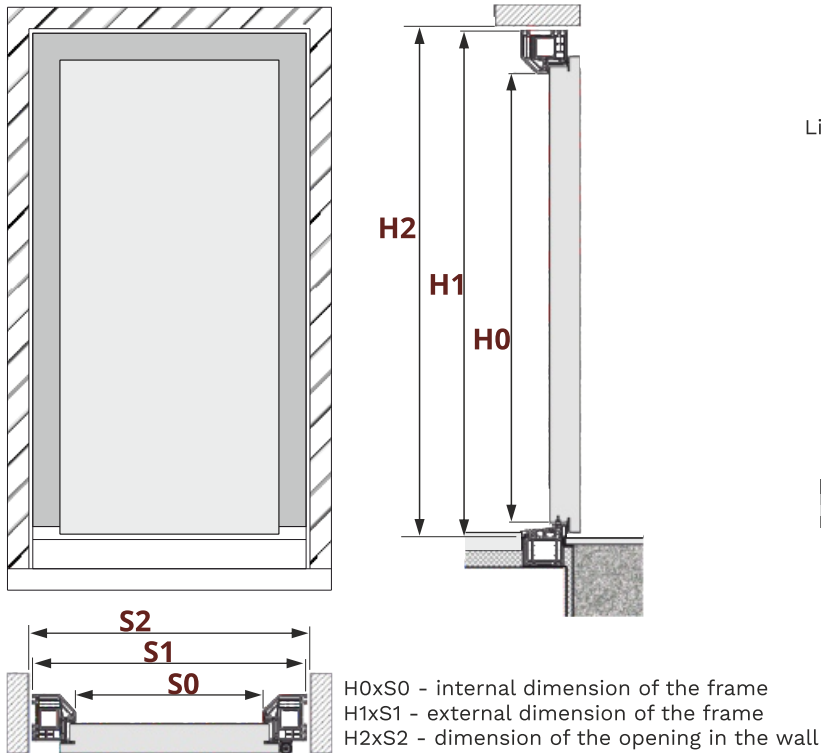

Dedicated installation kits for installing composite doors

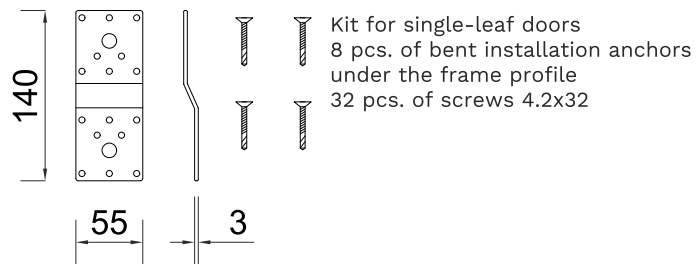

Do not require an overhang!

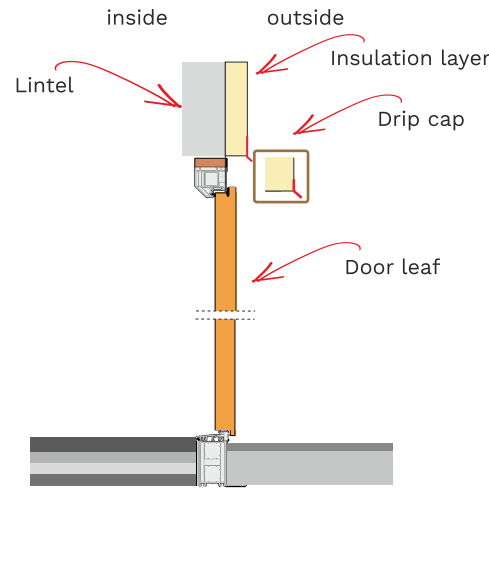

Optimal door and sidelight anchoring points

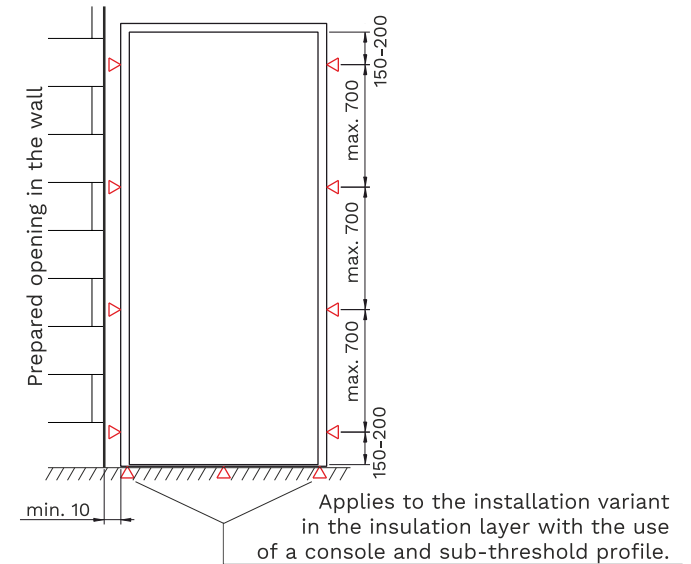

Use only for wider sidelights than 530 mm

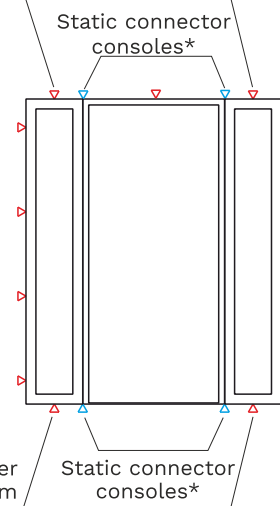

Use only for wider sidelights than 530 mm

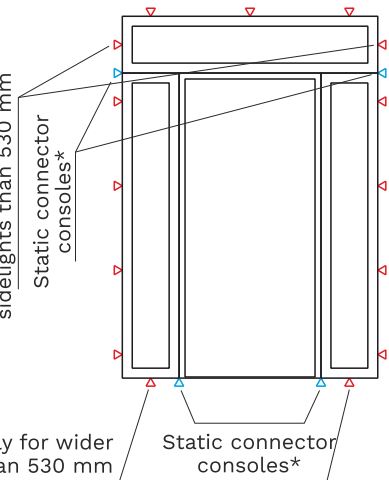

*Static connector anchoring consoles are supplied with sidelights.



Recommended composite door installation system

ULTIMATE line

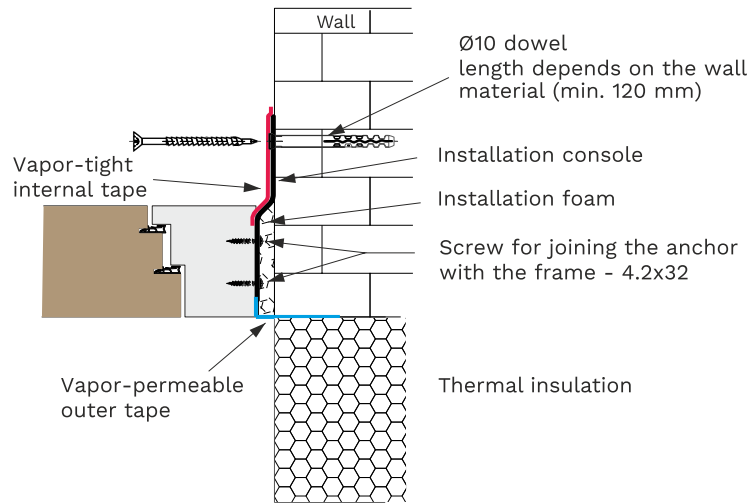

VISION line

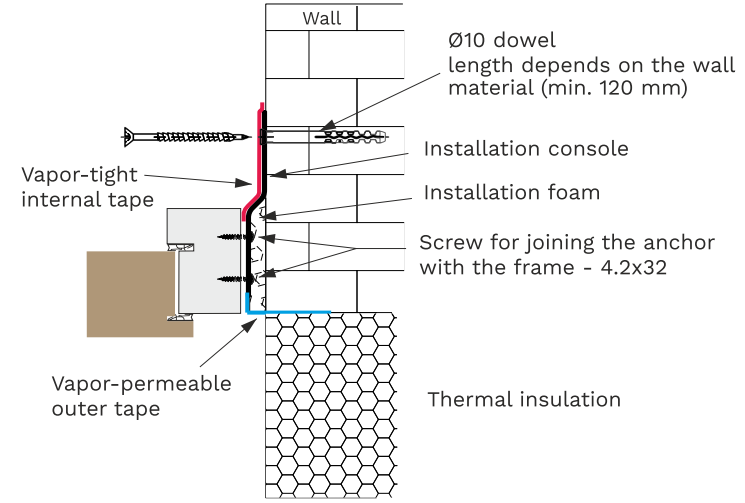

ARCTIC PLUS, ARCTIC and TOP line

Dedicated for installation in the insulation layer

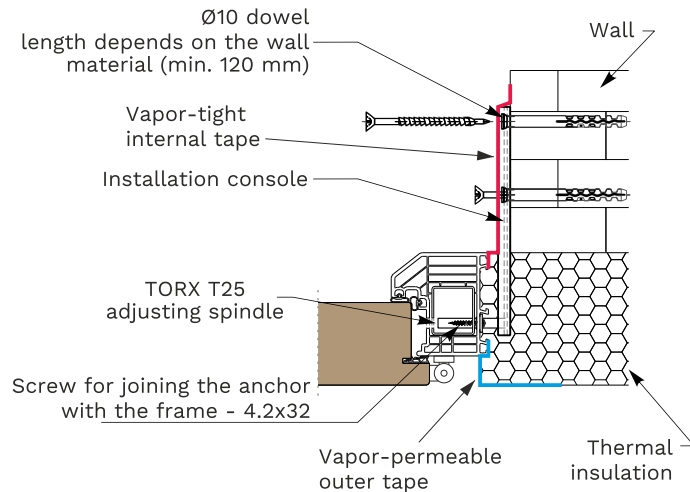

Dedicated for installation in the wall layer using dedicated connectors

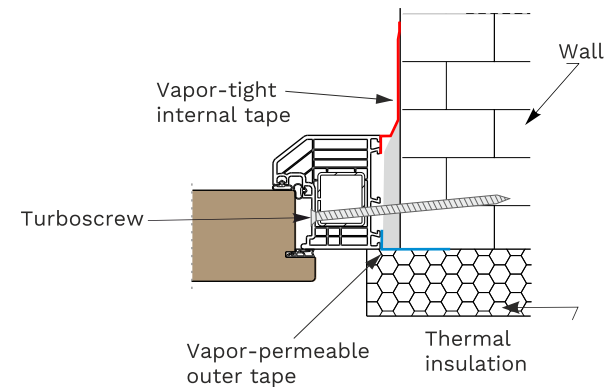



It is recommended to install the door on a sub-threshold profile and perform thermal insulation and waterproofing of the threshold part.

ULTIMATE line

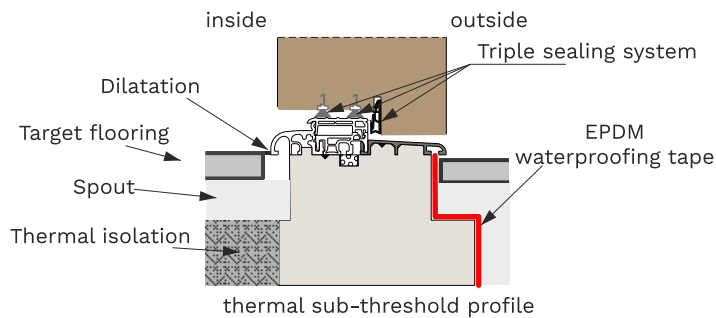

VISION, ARCTIC PLUS, ARCTIC and TOP line

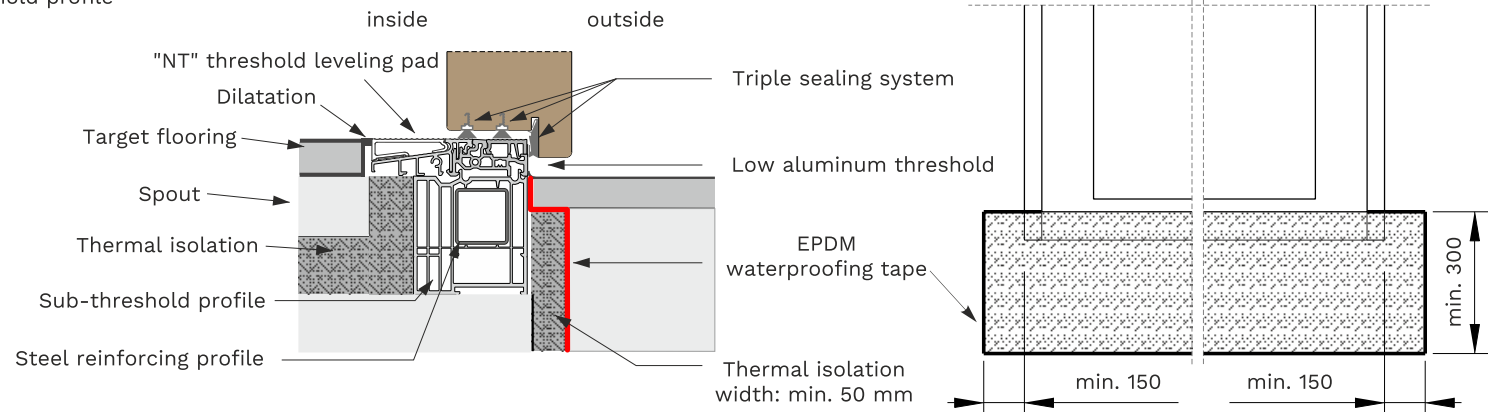

Available sizes of sub-threshold profiles - ULTIMATE line*

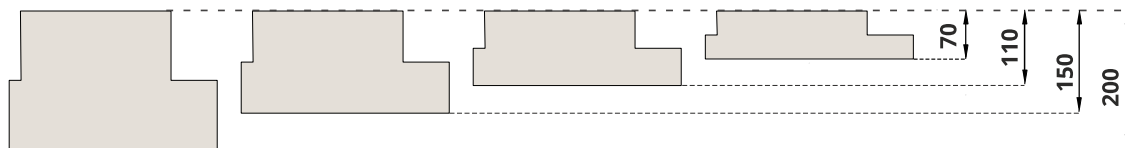

* Also available in other sizes.

VISION, ARCTIC PLUS, ARCTIC and TOP

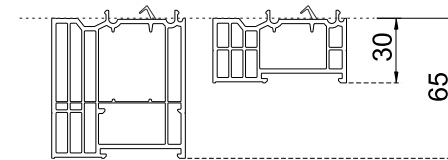

ENERGY AND SAVING WINDOWS

AESTHETICS AND QUALITY



Discover the offer of windows, perfectly matched to VIKKING composite doors, which create a unique and perfectly matched style of every modern home.

We are not afraid of even the most demanding projects!



VIKKING INNOVATION

The only PVC windows on the market with REAL WOOD surface decoration



INNOVATIVE IDEA

Wooden products are susceptible to many threats resulting from the destructive effect of moisture on the hygroscopic structure of wood. That is why we decorate the surface of PVC profiles to provide them with the aesthetics of precious wood and eliminate the effects and inconveniences resulting from the use of wood.

The unique decoration system created by the VIKKING team of engineers is subject to international patent protection. The surface decoration of PVC profiles in RW technology eliminates the need for veneering profiles and ensures everlasting durability of the obtained structure. Real Wood windows, unlike wooden windows, do not require expensive surface maintenance.

HIDDEN HINGES



NANO - PERFECT completely invisible welding

Window coating technology in all RAL colours with completely invisible welding technology sealing gives your windows a real character. Entrust us with your wishes and our designers will do their best to realise the most imaginative solutions.

RealWood[®]
look
created by VIKKING

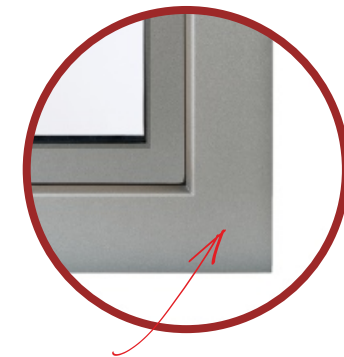



Patio doors

Discover our patio door systems

V-SLIDE NEO

Sliding patio doors



V-SPACE

Lift and slide patio doors

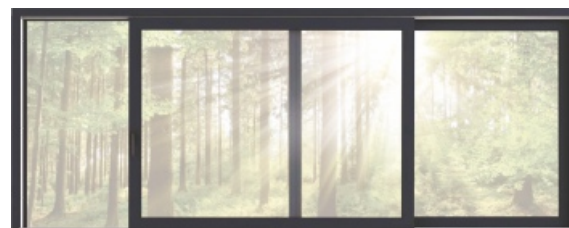

V-LIGHT

Tilt-and-slide patio doors





VISION NEO ENERGETO

INNOVATIVE DESIGN

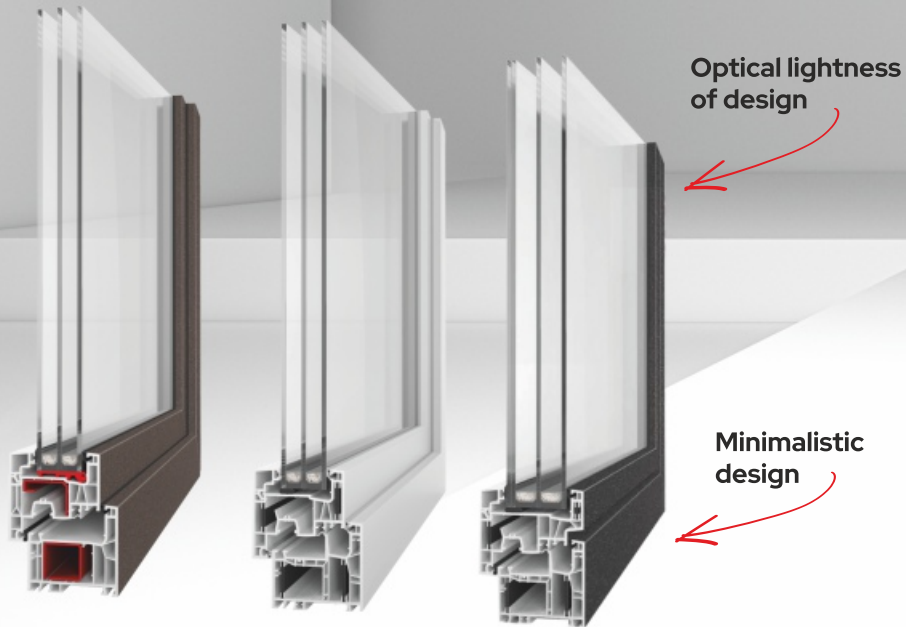

All information contained in this publication has been provided for promotional purposes only and cannot be the subject of a binding commercial offer. Due to printing conditions, the colors and patterns presented may slightly differ from the real ones. The individual production process, differences in the grain, color and surface structure of the door, as well as the manual creation of stained glass decorations make up the unique character of VIKKING composite doors and cannot be treated as binding. Any claims regarding different interpretations cannot constitute the basis for a complaint, and in the event of a difference of opinion, the reference document is the industry standard. The manufacturer reserves the right to technical improvements and product changes.

We manufacture and equip all products only based on individual customer orders. Before installing the products, read the instructions for installation, use and maintenance, and the warranty conditions. Failure to comply with the rules contained therein may void the warranty. We make every effort to ensure that our publications contain full and reliable knowledge about the offer, but we are not responsible for any inaccuracies. This publication is fully protected by copyright. Copying, including partial copying, always requires the consent of the manufacturer.

We manufacture composite doors and Real Wood windows based on our own proprietary, patented technological solutions. Unlawful infringement of intellectual property will be the basis for claims for damages. The offer is valid from 01.01.2024. On this day all previous offers expire.

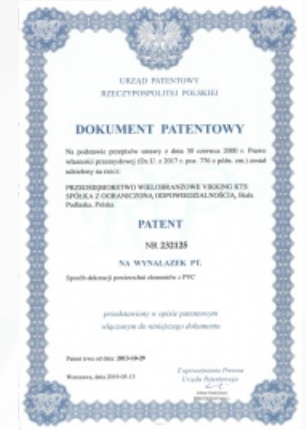

P.W. VIKKING KTS Sp. z o.o.
Aleja Solidarności 4
21-500 Biała Podlaska
Poland

Contact:
☎ +48 519 325 114
☎ +48 506 365 228
✉ info@vikking.eu

DISTRIBUTOR

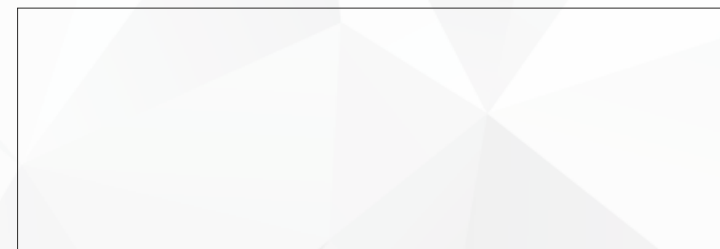

Stay updated
Like us on Facebook

vikking.eu